

# Gas cooktop

---

## User manual

NA30N6555T\* / NA30N7755T\* /  
NA36N6555T\* / NA36N7755T\*

---



**SAMSUNG**

## **WARNING**

**Never Operate the Top Surface Cooking Section of this Appliance Unattended.**

- **Failure to follow this warning statement could result in fire, explosion, or burn hazard that could cause property damage, personal injury, or death.**
- **If a fire should occur, keep away from the appliance and immediately call your fire department.**

**DO NOT ATTEMPT TO EXTINGUISH AN OIL/GREASE FIRE WITH WATER.**

**WARNING:** If the information in this manual is not followed exactly, a fire or explosion may result causing property damage, personal injury, or death.

- **DO NOT** store or use gasoline or other flammable vapors and liquids in the vicinity of this or any other appliance.
- **WHAT TO DO IF YOU SMELL GAS:**
  - **DO NOT** try to light any appliance.
  - **DO NOT** touch any electrical switch.
  - **DO NOT** use any phone in your building.
  - Immediately call your gas supplier from a neighbor's phone. Follow the gas supplier's instructions.
  - If you cannot reach your gas supplier, call the fire department.
- Installation and service must be performed by a qualified installer, service agency, or the gas supplier.

## Regulatory Notice

---

### 1. FCC Notice

#### **CAUTION**

**FCC CAUTION:** Any changes or modifications not expressly approved by the party responsible for compliance could void the user's authority to operate the equipment.

This device complies with Part 15 of FCC Rules. Operation is Subject to following two conditions:

- 1) This device may not cause harmful interference, and
- 2) This device must accept any interference received including interference that cause undesired operation.

For products sold in the US and Canadian markets, only channels 1~11 are available. You cannot select any other channels.

---

**FCC STATEMENT:**

This equipment has been tested and found to comply within the limits for a Class B digital device, pursuant to part 15 of the FCC Rules. These limits are designed to provide reasonable protection against harmful interference in a residential installation.

This equipment generates, uses, and can radiate radio frequency energy and, if not installed and used in accordance with the instructions, may cause harmful interference to radio communications. However, there is no guarantee that interference will not occur in a particular installation. If this equipment does cause harmful interference to radio or television reception, which can be determined by turning the equipment off and on, the user is encouraged to try to correct the interference by one or more of the following measures:

- Reorienting or relocating the receiving antenna
- Increasing the separation between the equipment and receiver
- Connecting the equipment to an outlet that is on a different circuit than the radio or TV
- Consulting the dealer or an experienced radio/TV technician for help.

---

**FCC RADIATION EXPOSURE STATEMENT:**

This equipment complies with FCC radiation exposure limits set forth for an uncontrolled environment. This equipment should be installed and operated so there is at least 8 inches (20 cm) between the radiator and your body. This device and its antenna(s) must not be co-located or operated in conjunction with any other antenna or transmitter.

**2. IC Notice**

The term “IC” before the radio certification number only signifies that Industry Canada technical specifications were met. Operation is subject to the following two conditions: (1) this device may not cause interference, and (2) this device must accept any interference, including interference that may cause undesired operation of the device.

This Class B digital apparatus complies with Canadian ICES-003. For products sold in the US and Canadian markets, only channels 1~11 are available. You cannot select any other channels.

## Regulatory Notice

---

### **IC RADIATION EXPOSURE STATEMENT:**

This equipment complies with IC RSS-102 radiation exposure limits set forth for an uncontrolled environment. This equipment should be installed and operated so there is at least 8 inches (20 cm) between the radiator and your body. This device and its antenna(s) must not be co-located or operated in conjunction with any other antenna or transmitter.

### **General safety instructions**

This unit has been tested and found to comply with the limits for a class B digital device, pursuant to Part 18 of the FCC rules. These limits are designed to provide reasonable protection against harmful interference in a residential installation. This unit generates, uses and can radiate radio frequency energy and, if not installed and used in accordance with the instructions, may cause harmful interference to radio communications.

However, there is no guarantee that interference will not occur in a particular installation. If this unit does cause harmful interference to radio or television reception, which can be determined by turning the unit off and on, the user is encouraged to try to correct the interference by one or more of the following measures:

- Reorienting or relocating the receiving antennae.
- Increasing the distance between the unit and receiver.
- Connecting the equipment to an outlet that is on a different circuit than the radio or TV.

# Contents

---

<b>Important safety information</b>	<b>6</b>	<b>Care and cleaning of the cooktop</b>	<b>19</b>
Read all instructions before using this appliance	6	Cooktop surface	19
Symbols used in this manual	6	Porcelain enamel surfaces (on some models)	19
California Proposition 65 Warning	6	Stainless steel surfaces (on some models)	19
Commonwealth of Massachusetts	6	Control knobs	20
General safety	7	Burner grates and components	20
Fire safety	7	Burner caps and heads	21
Gas safety	8	Burner bases	21
Electrical and grounding safety	8	Electrodes	22
Installation safety	9	Grates and wok grate	22
Location safety	9	Cast-iron griddle (for NA30N7755T*/NA36N7755T* only)	22
Cooktop safety	10	Burner head and cap replacement	23
		Burner cap	24
<b>Overview</b>	<b>11</b>	<b>Troubleshooting</b>	<b>25</b>
Layout	11	Checkpoints	25
What's included	12		
<b>Using the cooktop burners</b>	<b>12</b>	<b>Warranty (U.S.A)</b>	<b>26</b>
Ignition	12		
Cookware	13	<b>Warranty (CANADA)</b>	<b>28</b>
Install the grates.	14		
Wok grate (for NA30N7755T*/NA36N7755T* only)	15	<b>Appendix</b>	<b>30</b>
Griddle	15	Open Source Announcement	30
Using the Smart Connect feature	16	Model name & serial number	30
Using the hood control feature	18		

# Important safety information

---

## Read all instructions before using this appliance

---

- All electrical and gas equipment with moving parts can be dangerous. Please read the important safety instructions for this appliance in this manual. The instructions must be followed to minimize the risk of injury, death, or property damage.
- Save this manual. Please Do Not Discard.

## Symbols used in this manual

---

### **WARNING**

Hazards or unsafe practices that may result in severe personal injury or death.

### **CAUTION**

Hazards or unsafe practices that may result in electric shock, personal injury, or property damage.

### **NOTE**

Useful tips and instructions

These warning icons and symbols are here to prevent injury to you and others. Please follow them explicitly. After reading this section, keep it in a safe place for future reference.

## California Proposition 65 Warning

---

### **WARNING**

Cancer and Reproductive Harm - [www.P65Warnings.ca.gov](http://www.P65Warnings.ca.gov).

## Commonwealth of Massachusetts

---

This product must be installed by a licensed plumber or gas fitter qualified or licensed by the State of Massachusetts. When using ball-type gas shut-off valves, you must use the T-handle type. Multiple flexible gas lines must not be connected in series.

---

## General safety

---

### WARNING

To reduce the risk of fire, electric shock, personal injuries, and/or death, observe the following precautions.

- **Do not touch** any part of the cooktop, including but not limited to cooktop burners during or immediately after cooking.
- **Know** the location of the gas shut-off valve and how to shut it off.
- **Make sure** the hold down brackets are properly installed on the cooktop. See the installation instructions for more information.
- **Do not let children near** the cooktop. Do not let children go onto the cooktop. Do not let children play with the cooktop or any part(s) of the cooktop. Do not leave children unattended in an area where the cooktop is in use.
- **Remove** all packaging materials from the cooktop before operating to prevent ignition of these materials. Keep all packaging materials out of children's reach. Properly dispose the packaging materials after the cooktop is unpacked.
- **Do not store** any object of interest to children on the cooktop or backguard of the cooktop. Children climbing on the cooktop to reach items could be killed or seriously injured.
- **Do not operate** the cooktop if the cooktop or any part of the cooktop is damaged, malfunctioning, or missing parts.
- **Do not use** the cooktop as a space heater. Use the cooktop for cooking only.
- **Use** only dry pot holders.
- **Do not use** the cooktop to heat unopened food containers.
- **Unplug** or **disconnect** the power cord before servicing.
- Never store combustible materials (dishtowels, paper products, etc.) or packaged or canned food under the cooktop in a way that would let them come in contact with the underside of the cooktop. The combustible material could catch fire and the packaged or canned food could explode.
- Make sure the gas line is not compressed or bent by heavy objects. Otherwise, gas leaks or incomplete combustion may occur.

- Do not lean on the cooktop as you may turn the control knobs inattentively.
- Do not stand on top of the appliance or place objects (such as laundry, an oven cover, lighted candles, lighted cigarettes, dishes, chemicals, metal objects, etc.) on the appliance.
  - Items, such as a cloth, may get caught in the door.
  - This may result in electric shock, fire, problems with the product, or injury.

---

## Fire safety

---

### WARNING

To reduce the risk of fire, electric shock, personal injuries, and/or death, observe the following precautions.

- **Do not store, place or use** flammable or combustible materials such as charcoal, paper, plastic, pot holders, linens, curtains, gasoline or other flammable vapors or liquids near or inside the range.
- **Do not wear** loose fitting or hanging garments while using the cooktop.
- To avoid grease buildup, **regularly clean** the vents.
- **Do not let** pot holders or other flammable materials touch a heating element. Do not use a towel or other bulky items made out of cloth in place of a pot holder.
- **Do not use** water on a grease fire. To put out a grease fire, turn off the heat source and smother the fire with a tight-fitting lid or use a multipurpose dry chemical or foam-type fire extinguisher.
- **Do not heat** unopened food containers. The buildup of pressure may cause the container to burst and result in injury.
- Always check if the burners are combusting normally. Overheating may cause a fire, and incomplete combustion may cause carbon-monoxide poisoning.

# Important safety information

## Gas safety

### WARNING

To reduce the risk of fire, electric shock, personal injuries, and/or death, observe the following precautions.

#### Checking for gas leaks

- Leak testing of the appliance must be conducted according to the manufacturer's instructions. **Do not use** a flame to check for gas leaks. Use a brush to spread a soapy water mixture around the area you are checking. If there is a gas leak, you will see small bubbles in the soapy water mixture at the leak point.

#### If you smell gas:

- **Close the valve** and do not use the cooktop.
- **Do not light** a match, candle, or cigarette.
- **Do not turn on** any gas or electric appliances.
- **Do not touch** any electrical switches or plug a power cord into an outlet.
- **Do not use** any phone in your building.
- **Evacuate** the room, building, or area of all occupants.
- **Immediately call** your gas supplier from a neighbor's phone. Follow the gas supplier's instructions.
- If you cannot reach your gas supplier, call the fire department.

## Electrical and grounding safety

### WARNING

To reduce the risk of fire, electric shock, personal injuries, and/or death, observe the following precautions.

- Plug the power cord into a grounded 3-prong outlet.
- **Do not remove** the grounding prong.
- **Do not use** an adapter or an extension cord.
- **Do not use** a damaged power plug, power cord, or loose power outlet.
- **Do not modify** the power plug, power cord, or power outlet in any way.
- **Do not put** a fuse in a neutral or ground circuit.
- Use a dedicated 120-volt, 60-Hz, 20-amp, AC, fused electrical circuit for this cooktop. A time-delay fuse or circuit breaker is recommended. Do not plug more than one appliance into this circuit.
- **Do not connect** the ground wire to plastic plumbing lines, gas lines, or hot water pipes.
- This cooktop **must be Earth grounded**. In the event of a malfunction or breakdown, grounding will reduce the risk of electrical shock by providing a path for the electric current. This cooktop is equipped with a cord having a grounding plug. The plug must be firmly plugged into an outlet that is properly installed and grounded in accordance with the local codes and ordinances. If you are unsure whether your electrical outlet is properly grounded, have it checked by a licensed electrician.
- The cooktop is supplied with a 3-pronged grounded plug. This cord must be plugged into a matching, grounded 3-prong outlet that meets all local codes and ordinances. If codes permit the use of a separate ground wire, we recommend that a qualified electrician determine the proper path for this ground wire.
- Electrical service to the cooktop must conform to local codes. Barring local codes, it should meet the latest ANSI/NFPA No. 70 - Latest Revision (for the U.S.) or the Canadian Electrical Code CSA C22.1 - Latest Revisions.
- It is the personal responsibility of the cooktop owner to provide the correct electrical service for this cooktop.

---

## Installation safety

---

### WARNING

To reduce the risk of fire, electric shock, personal injuries, and/or death, observe the following precautions.

- Have your cooktop installed and properly grounded by a **qualified installer**, in accordance with the installation instructions. Any adjustment and service should be performed only by qualified gas cooktop installers or service technicians.
- **Do not attempt** to service, modify, or replace your cooktop or any part of your cooktop unless it is specifically recommended in this manual. All other service should be referred to a qualified technician.
- Always use new flexible connectors when installing a gas appliance. **Do not use** old flexible connectors.
- **Make sure** the hold down brackets are properly installed on the cooktop. See the installation instructions for more information.
- **Remove** all tape and packaging materials.
- **Remove** all accessories from the cooktop, Grates and griddles are heavy. Use caution when handling them.
- **Make sure** no parts came loose during shipping.
- **Make sure** your cooktop is correctly installed and adjusted by a qualified service technician or installer for the type of gas (natural or LP) you will use. For your cooktop to utilize LP gas, the installer must replace the 5 surface burner orifices with the provided LP orifice set, and reverse the GPR adapter. These adjustments must be made by a qualified service technician in accordance with the manufacturer's instructions and all codes and requirements of the authority having jurisdiction. The qualified agency performing this work assumes the gas conversion responsibility.
- Installation of this cooktop must conform with local codes or, in the absence of local codes, with the National Fuel Gas Code, ANSI Z223.1/NFPA.54, latest edition. In Canada, installation must conform with the current Natural Gas Installation Code, CAN/CGA-B149.1, or the current Propane Installation Code, CAN/CGA-B149.2, and with local codes where applicable. This cooktop has been design-certified by ETL according to ANSI Z21.1, latest edition, and Canadian Gas Association according to CAN/CGA-1.1, latest edition.

- 
- Make sure the middle valve has adequate capacity and is not clogged.
  - This cooktop must be installed by a qualified technician. Otherwise, gas leaks, fire, or defective ignition may occur.

## Location safety

---

### WARNING

To reduce the risk of fire, electric shock, personal injuries, and/or death, observe the following precautions.

- This cooktop is for indoor, household use only. **Do not install** the cooktop in areas exposed to the weather and/or water.
- **Do not install** the cooktop in a place which is exposed to a strong draft.
- Select a location where a grounded, 3- prong outlet is easily accessible.
- If the cooktop is located near a window, **do not hang** long curtains or paper blinds on that window.
- For the cooktop to ventilate properly, there must be enough clearance at the top, back and sides of the cooktop, and underneath the cooktop. The vents allow the necessary exhaust for the cooktop to operate properly with correct combustion.
- **Make sure** the wall coverings around the cooktop can withstand heat up to 194 °F (90 °C).
- Cabinet storage above the surface of the cooktop should be avoided. If cabinet storage above the cooktop is necessary: allow a minimum clearance of 30 inches (76.2 cm) between the cooking surface and the bottom of the cabinets.

# Important safety information

## Cooktop safety

### WARNING

To reduce the risk of fire, electric shock, personal injuries, and/or death, observe the following precautions.

- Select cookware that is designed for range top cooking. Use cookware that is large enough to cover the burner grates. Adjust the burner flames so that the flames do not extend beyond the bottom of the cookware.
- **Make sure** all burners are off when not in use.
- **Do not use** aluminium foil to line the grates or any part of the cooktop.
- **Do not leave** burners unattended on medium or high heat settings.
- Before igniting, **make sure** all burner caps are properly in place and all burners are level.
- **Always use** the LITE position when igniting the burners and make sure the burners have ignited. If ignition fails, turn the knob to OFF and wait until the gas has dissipated.
- When you set a burner to simmer, **do not turn** the knob quickly. Make sure the flame stays on.
- **Do not place** any objects other than cookware on the cooktop.
- This cooktop is designed to cook with a wok or wok ring attachment. If foods are flamed, they should only be flamed under a ventilation hood that is on.
- Before removing or changing cookware, turn off the burners.
- Remove food and cookware immediately after cooking.
- Before removing any parts of the burner for cleaning, make sure the cooktop is off and completely cool.
- After cleaning the burner spreader, **make sure** it is completely dry before re-assembling.
- To avoid carbon monoxide poisoning, **do not pour** water into the cooktop well while cleaning.
- To avoid cookware discoloration, deformity, and/or carbon monoxide poisoning, **do not use** cookware that is substantially larger than the grate.
- **Make sure** cookware handles are turned to the side or rear of the cooktop and not over other surface burners.
- Stand away from the cooktop while frying.

- Always heat frying oils slowly, and watch as they heat. If you are frying foods at high heat, carefully watch during the cooking process. If a combination of fats or oils is to be used during frying, mix them together before heating.
- Use a deep-fryer thermometer whenever possible. This prevents overheating the fryer beyond the smoking point.
- Use a minimum amount of oil when shallow pan-frying or deep-frying. Avoid cooking unfrozen food or food with excessive amounts of ice.
- Before moving cookware full of fats or oils, make sure it has completely cooled.
- To prevent delayed eruptive boiling, always allow heated liquids to stand at least 20 seconds after you have turned off the burner so that the temperature in the liquid can stabilize. In the event of scalding, follow these first aid instructions:
  - 1.** Immerse the scalded area in cool or lukewarm water for at least 10 minutes.
  - 2.** Do not apply any creams, oils, or lotions.
  - 3.** Cover with a clean, dry cloth.
- If a power failure occurs or the electric ignition fails to operate, do not use matches or lighters to ignite the burners. This may cause a fire or physical burns.
- Do not place and use electric-powered cooking devices such as IH rice cookers or desktop cooking heaters on top of your cooktop. Electromagnetic forces from these appliances may cause the cooktop to malfunction.
- Opening a window or turning on a ventilation fan or hood is recommended when using the cooktop.

### CAUTION

If the cooktop is installed above an oven, do not use the cooktop while the oven's self-cleaning function is on.

# Overview

## Layout

30" Model: NA30N6555T\* / NA30N7755T\*

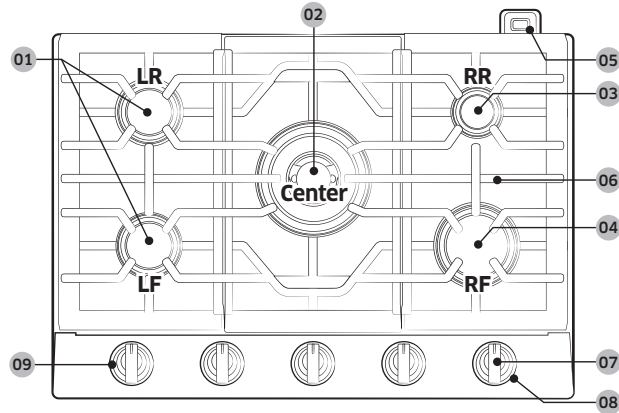

36" Model: NA36N6555T\* / NA36N7755T\*

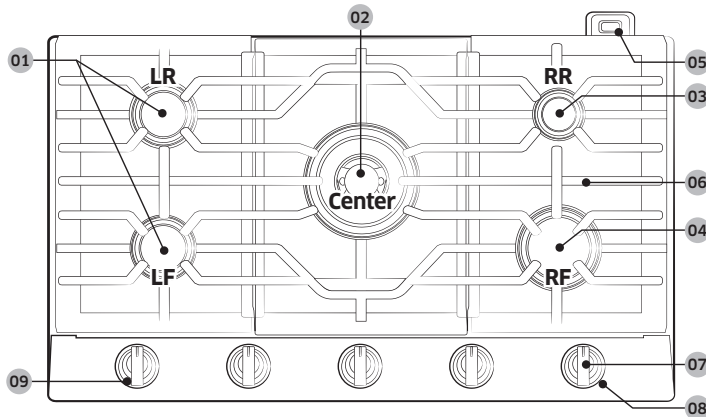

- |   |   |
|---|---|
| <p><b>01</b> Left Front/Left Rear<br/>Semi rapid burners 9,500BTU</p> <p><b>03</b> Right Rear<br/>Simmer burner<br/>5,000 BTU</p> <p><b>05</b> Wi-Fi module</p> <p><b>07</b> Surface burner knobs (5 pcs)</p> <p><b>09</b> Bluetooth button (below knob)<br/>only NA30N7755T*/NA36N7755T*</p> | <p><b>02</b> Center<br/>Power burner<br/>NA30N6555T*/NA36N6555T* : 19,000 BTU<br/>NA30N7755T*/NA36N7755T* : 22,000 BTU</p> <p><b>04</b> Right Front<br/>Rapid burner<br/>13,000 BTU</p> <p><b>06</b> Grate (3)</p> <p><b>08</b> Wi-Fi button (below knob)</p> |
|---|---|

Each burner has a corresponding knob that lets you to set the flame level from LO to HI. In addition, each burner knob has a Lite setting. Turning a knob to Lite ignites the corresponding burner. The burner indicators are located above each knob and show which burner the knob controls. Each burner is designed for specific cooking purposes. See the table below.

Burner	Purpose	Food type	Characteristics
Semi rapid (LF, LR)	General heating/ Low simmering	General food, casseroles	General-purpose cooking
Power (Center)	Power heating/ Low simmering	Boiling food, tomato sauce	Maximum output
Simmer (RR)	Low simmering	Chocolate, casseroles, sauces	Delicate food that requires low heat for a long time
Rapid (RF)	Quick heating	General	General-purpose cooking

# Overview

## What's included

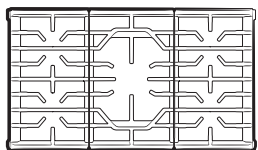

Surface burner grates (3) \*



Surface burners and caps (5) \*



Aluminum griddle (1) \*  
(NA30N6555T/  
NA36N6555T)

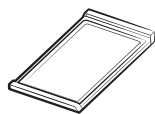

Cast-iron griddle (1) \*  
(NA30N7755T/  
NA36N7755T)



Wok grate (1) \*  
(NA30N7755T/  
NA36N7755T)

### NOTE

If you need an accessory marked with an asterisk (\*), you can buy it from the Samsung Contact Center (1-800-726-7864).

# Using the cooktop burners

## Ignition

### CAUTION

The knob LED indicates if a burner knob has been turned on. It does not indicate if the burner flame is on.

Check for an actual flame, whether the knob LED is on or off.

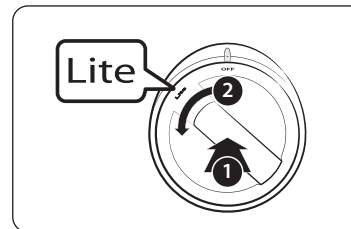

Make sure all cooktop burners are properly installed. To light a burner:

1. Push in the control knob, and then turn it to the Lite position. The knob LED turns on and you will hear a “clicking” sound indicating the electronic ignition system is working properly.
2. After the cooktop burner lights, turn the control knob to shift it out of the Lite position and turn off the electronic ignition system.
3. Turn the control knob to adjust the flame level.

### NOTE

The dual valve located to the center controls the inner/outer flame of the dual burner [Center].

When the inner / outer flame is on the HI position, the flame size gets smaller from the outside when turning the knob from HI to LO. To control the inner flame, push and turn the knob once again at the position where it starts to control inner flame.

### Manual ignition

If there is a power failure, you can ignite the burner manually. Use caution when doing this.

1. Hold a long gas grill lighter to the cooktop burner you want to light.
2. Push in the control knob for that burner, and then turn it to the Lite position. Turn on the grill lighter to ignite the burner.
3. After the burner is lit, turn the control knob to adjust the flame level.

---

## Flame level

The flames on the burners should always stay under the cookware, and should not extend beyond the cookware bottom at any time.

### WARNING

- Flames larger than the cookware bottom may result in a fire or physical injury.
- When you set a burner to simmer, do not turn the burner knob quickly. Watch the flame to make sure it stays on.
- After turning on a surface burner, make sure that the burner has ignited even if the knob LED is on. Adjust the level of the flame by turning the burner knob.
- Always turn off the surface burner controls before removing cookware. All surface burner controls should be turned OFF when you are not cooking.
- Always turn the burners off before you go to sleep or go out.
- If you smell gas, turn off the gas to the cooktop and call a qualified service technician. NEVER use an open flame to locate a leak.
- If the LED on the control knob doesn't go on when the surface burner has ignited, call a qualified service technician.
- If the knob LED illuminates, but the surface burner does not ignite, turn off the control knob immediately.
- Do not operate the burner for an extended period of time without cookware on the grate. The finish on the grate may chip without cookware to absorb the heat.
- Be sure the burners and grates are cool before you place your hand, a pot holder, cleaning cloths or other materials on them.

---

## Cookware

### Requirements

- Flat bottom and straight sides
- Tight-fitting lid
- Well-balanced with the handle weighing less than the main portion of the pot or pan.

### Material characteristics

- **Aluminum:** An excellent heat conductor. Some types of food may cause the aluminum to darken. However, anodized aluminum cookware resists staining and pitting.
- **Copper:** An excellent heat conductor but discolors easily.
- **Stainless steel:** A slow heat conductor with uneven cooking performance but is durable, easy to clean, and resists staining.
- **Cast-Iron:** A poor conductor but retains heat very well.
- **Enamelware:** Heating characteristics depend on the base material.
- **Glass:** A slow heat conductor. Use only glass cookware that is specified for cooktop cooking or oven use.
- **Heatproof Glass-Ceramic:** Can be used for either surface or oven cooking. It conducts heat very slowly and cools very slowly. Check cookware manufacturer's directions to be sure it can be used on a gas cooktop.

### Size limitations

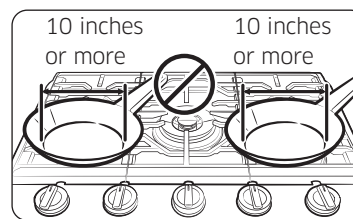

### CAUTION

- Do not place a pan or pot with a bottom diameter of about 10 inches or more on the RF or LF burner.

## Using the cooktop burners

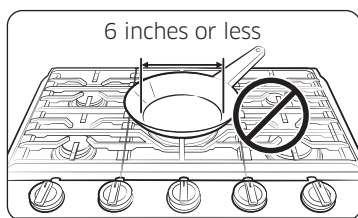

### **CAUTION**

- Do not place a pan or pot with a bottom diameter of about 6 inches or less on the center grate. This cookware may tip over. Use the rear burners for this small-sized cookware.

- Always make sure cookware handles are turned to the side or rear of the cooktop and not over other surface burners. This will minimize the chance of burns, spillovers, and the ignition of flammable materials that can occur if pots or pans are bumped accidentally.
- If using glass cookware, make sure it is designed for cooktop cooking.
- Never leave plastic items on the cooktop. They can melt or ignite. Heating a sealed plastic container can cause a building up of dangerous pressure which can cause the container to explode.
- Make sure you hold the handle of a wok or a small one-handed pot while cooking.

### Install the grates.

#### **NOTE**

Install the grates as instructed below for longest life. When installed properly, the openings in the grates are centered over the burners.

The three cooktop grates are designed to fit in specific positions on the cooktop. For maximum stability, these grates should only be used in their proper positions.

- Please place the grate marked with the letter 'L' on the left side, and the one with the letter 'R' on the right side.
- The middle grate must be installed with the filled-in section, marked 'BACK', oriented towards the back of the cooktop.

The back of the right grate is notched to help you orient the grates correctly. See the illustration below.

To replace the grates correctly, follow these steps:

1. Locate the notch on the back of the right grate.
2. Orient the right grate so that it is on the right side of the cooktop with the notch in the back.
3. Gently lower the legs of the right grate into the corresponding dimples on the cooktop.
4. Gently lower the legs of the remaining two grates into the corresponding dimples on the cooktop as shown in the illustration.

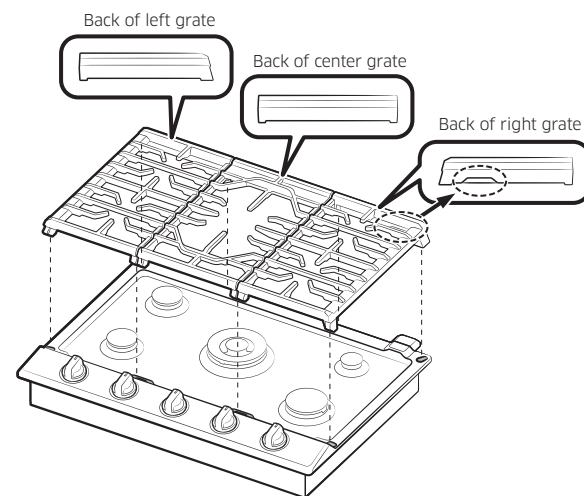

## Wok grate (for NA30N7755T\*/NA36N7755T\* only)

Woks are often used for stir frying, pan frying, deep frying, and poaching. The provided wok grate supports 12" to 14" woks.

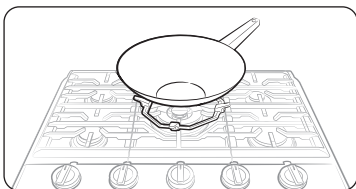

1. Turn off all burners, and wait until the grates completely cool down.
2. Place the wok grate on the center or right front grate.
3. Put a wok on the wok grate. Make sure the wok settles on the wok grate.
4. Turn on the burner, and adjust the flame level as appropriate.

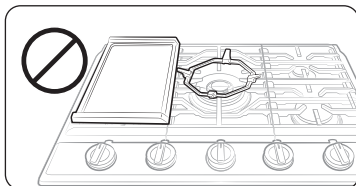
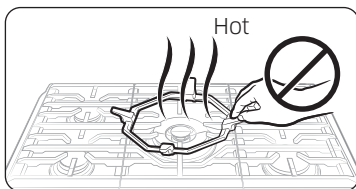

### ⚠ CAUTION

- Do not remove the wok grate until the cooktop grates, surfaces, and wok grate completely cool down.
- When you use the wok with the cooktop or when the oven is on, the wok grate on the cooktop may become very hot. Use oven gloves when placing or removing the wok grate.
- Do not use pans with a flat bottom or woks with a diameter less than the wok ring diameter. The pan or wok may tip over.
- Do not use an oversized pan. The burner flames may spread out, causing damage nearby.
- Do not use the wok grate and the griddle at the same time.
- This cooktop is not designed to flame foods. If foods are flamed, they should only be flamed under a ventilation hood that is on.

## Griddle

The removable coated griddle provides an extra cooking surface. This is useful especially when cooking meat, pancakes, or other foods requiring a large cooking area.

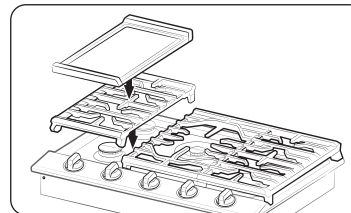

The griddle can be used only with the left rear and front burners on the left grate. Use caution when putting the griddle on the left grate.

In most cases, you should preheat the griddle before cooking. See the table below.

Type of Food	Preheating Time	Preheat setting	Cook setting
Pancakes	5 - 10 min.	MED	MED - LO
Hamburgers	5 - 10 min.	MED	MED
Fried Eggs	5 - 10 min.	MED	MED
Bacon	5 - 10 min.	MED	MED
Breakfast Sausages	5 - 10 min.	MED	MED

### ⚠ CAUTION

- You must turn on the LF and LR burners when you use the griddle.
- Do not remove the griddle until the cooktop grates, surfaces, and griddle itself cool down.
- If you leave the griddle on the cooktop, it may become very hot when you use the cooktop. Use oven gloves when placing or removing the griddle.
- Do not set the burners to HI when you use the griddle. This can damage the coating of the griddle and burn the food you are cooking.
- Do not use metal utensils that can damage the griddle surface.
- Do not use the griddle for other purposes, for example, as a cutting board or a storage shelf.
- Do not cook excessively greasy foods. The grease may spill over.
- The griddle is quite heavy because it is made of cast iron. Use both hands when placing or removing the griddle.

## Using the cooktop burners

---

### NOTE

- You may need to adjust heat settings for the griddle over time.
- The griddle may discolor over time as it becomes seasoned with use.
- Do not let rust remain on the griddle. If rust appears on the griddle, remove it as soon as possible.
- Do not clean the griddle in a self-cleaning oven.

## Using the Smart Connect feature

---

The cooktop has built in a Wi-Fi module that you can use to sync the cooktop with the SmartThings app. On the SmartThings app, you can:

- monitor the operating status and the power level settings of the cooktop elements.
- check and change the timer settings.

Functions that can be operated from the SmartThings app may not work smoothly if communication conditions are poor or the product is installed in a place with a weak Wi-Fi signal.

### How to connect the cooktop

Before you can use the remote features of your Samsung oven or cooktop, you must pair it to the SmartThings app.

- 1.** Download and open the SmartThings app on your smart device.
- 2.** Follow the app's on-screen instructions, and then press the **Smart Connect** button for 3 seconds to connect your cooktop.
- 3.** Once the process is complete, the Smart Connect LED indicator stops blinking and turns solid. The cooktop is connected successfully.
- 4.** If the Smart Connect LED indicator does not turn in, follow the instruction on the app to reconnect.

**NOTE**

The **Smart Connect** button is below the RF control knob. If you need to press the **Smart Connect** button, remove the RF control knob by grasping it and then pulling it straight up.

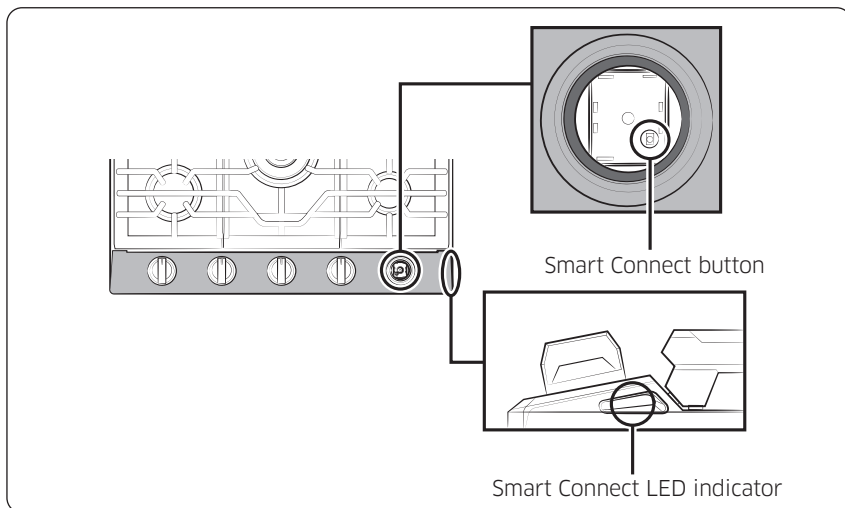

**To monitor the cooktop remotely**

1. Make sure the Smart Connect LED indicator turns on. If the Smart Connect LED indicator does not turn on, press the **Smart Connect** button. The cooktop can now be monitored remotely with a connected remote device.
2. Select the cooktop icon on the SmartThings app to open the cooktop monitor app.

**Smart connect on/off**

If you set the Smart Connect to Off, mobile devices cannot connect to the cooktop. To turn Smart Connect on, follow these steps:

1. Pull the RF control knob straight up to remove it.
2. Press the **Smart Connect** button.

**NOTE**

The Smart Connect LED indicator is on when Smart Connect is enable. The Smart Connect LED indicator is off when Smart Connect is not enabled.

3. Put in the RF control knob.

**NOTE**

- The cooktop continues operating even if the Wi-Fi connection is lost.
- **SmartThings Application** will not work properly if the Wi-Fi Connection is unstable.
- See the SmartThings app manual for detailed information.
- For further instructions, refer to the SmartThings app web manual at [www.samsung.com](http://www.samsung.com)

# Using the cooktop burners

## Using the hood control feature

### NOTE

This product features a Bluetooth device that you can use to connect the cooktop to Samsung hood control models. Through the Bluetooth connection, you can use the hood control function on the SmartThings app. (for NA30N7755T\*/NA36N7755T\* only)

For matching hood control-enabled cooktops and hoods, refer to the below table.

	Gas cooktop	Hood
Model	NA30N7755T* NA36N7755T*	NK30K7000W* NK36K7000W*

To connect to a hood control model and a hood:

1. Download and run the SmartThings app on your smartphone. Then, complete the Smart Connect procedure to connect to the cooktop.
2. Follow the Bluetooth instructions of the hood control model and activate the Bluetooth connection.
3. Press the **Bluetooth** icon  on the hood control panel. The Bluetooth icon LED blinks.
4. Press the **Bluetooth** button on the cooktop. Pairing begins.
5. When Bluetooth pairing is finished, the Bluetooth icon LED stops blinking and glows steadily.
6. Follow the instructions in the user manual of the hood control model and the App guide to use the hood control.

### NOTE

The **Bluetooth** button is below the LF control knob. If you need to press the **Bluetooth** button, remove the LF control knob by grasping it and then pulling it straight up.

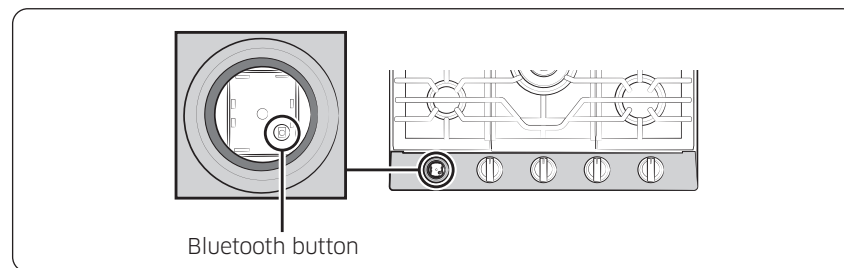

### Bluetooth on/off

Press the **Bluetooth** icon  on the hood control panel.

### NOTE

- The Bluetooth icon LED on the hood is on when Bluetooth is enabled. The Bluetooth icon LED on the hood is off when Bluetooth is not enabled.
- If the Smart Connect connection is not successful, you cannot use the SmartThings app to monitor and control the hood.
- Without a Smart Connect connection to the cooktop, you can use a Bluetooth connection to pair the cooktop with the hood and sync them. To do this, follow the Bluetooth connection steps on the left.
- Bluetooth will not work properly if the Bluetooth connection is unstable.
- See the SmartThings app manual for detailed information.

# Care and cleaning of the cooktop

## **⚠ WARNING**

Be sure electrical power is off and all surfaces are cool before cleaning any part of the cooktop.

## **Cooktop surface**

We recommend that you remove food spills immediately after they take place.

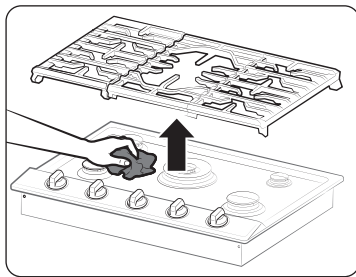

1. Turn off all surface burners.
2. Wait until all burner grates cool down, and then remove them.
3. Clean the cooktop surface using a soft cloth. If food spills run into gaps of the burner components, remove the burner cap and the head, and wipe up the spills.
4. When you are done cleaning, reinsert the burner components, and then put the burner grates back into position.

## **Porcelain enamel surfaces (on some models)**

The porcelain enamel finish is sturdy but breakable if misused. This finish is acid-resistant. However, any acidic foods with high sugar content (such as fruit, juices, tomatoes, or vinegar) should not be permitted to remain on the finish.

If an acidic food spills on the cooktop while it is hot, turn off all burners, and then use a dry paper towel or cloth to wipe the spill up right away. When the surface has cooled, wash it with an all-purpose cleaner and water. Rinse well. For other spills, such as fat splatterings, wash the cooktop with soap and water or an all-purpose cleaner after the surface has cooled. Rinse well. Polish with a dry cloth.

## **Stainless steel surfaces (on some models)**

1. Remove any spills, spots, and grease stains using a soft, wet cloth.
2. Apply an approved stainless steel cleanser to a cloth or paper towel.
3. Clean one small area at a time, rubbing with the grain of the stainless steel if applicable.
4. When done, dry the surface using a soft, dry cloth.
5. Repeat steps 2 through 4 as many times as necessary.

## **⚠ CAUTION**

- Do not use a steel-wool pad or abrasive cleaner, which can scratch or damage the surface.
- Do not remove the cooktop surface to clean it. The gas lines leading to the burner manifolds can be damaged, resulting in a fire or system failure.
- Do not pour water into the cooktop well while cleaning the cooktop. This could leak down into the cooktop gas and electrical systems creating a risk of electrical shock or high levels of Carbon Monoxide due to corrosion of the gas valves or ports.
- Do not spray any type of cleanser into the manifold holes. The ignition system is located in those holes and must be kept free of moisture.
- Do clean the cooktop or stainless steel parts with:
  - Caustic lye (sodium hydroxide) or cleaners containing this chemical
  - Hard or steel wool pads
  - Abrasive materials or chemicals.

# Care and cleaning of the cooktop

## Control knobs

Make sure all surface burner knobs are in the **OFF** position.

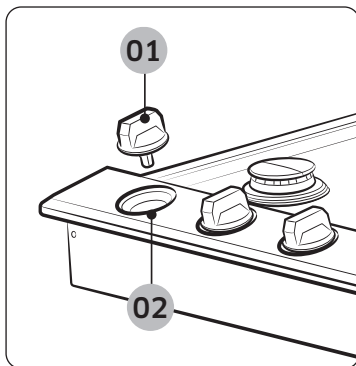

**01** Grasp each knob and pull straight up to remove.

**02** Spill protector. Do not remove.

- 1.** Pull knobs off the control valve stems
- 2.** Clean the knobs in warm, soapy water. Then rinse and dry them thoroughly.
- 3.** Clean the stainless steel surfaces using stainless steel cleaner.
- 4.** Re-attach the knobs in the **OFF** position to the control valve stems.

### ⚠ CAUTION

- Do not clean the control knobs in a dish washer.
- Do not spray cleansers directly onto the control panel. Moisture entering the electric circuits may cause electric shock or product damage.

## Burner grates and components

Turn off all surface burners and make sure they have all cooled down.

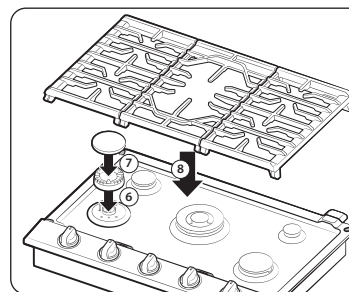
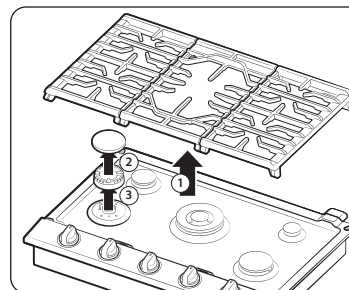

- 1.** Remove the burner grates.
- 2.** Remove the burner caps from the burner heads.
- 3.** Remove the burner heads from the valve manifolds to reveal the starter electrodes.
- 4.** Clean all removable grates and burner components in warm, soapy water. Do not use steel-wool pads or abrasive cleaners.
- 5.** Rinse and dry grates and burner components thoroughly.
- 6.** Return the burner heads to their positions on top of the manifold valves. Make sure a starter electrode is inserted through the hole in each burner head.

### 📖 NOTE

See pages **22**, **23**, and **24** for detailed burner component re-assembly instructions.

- 7.** Return the burner caps to their positions on top of the burner heads. To ensure proper and safe operation, make sure the burner caps lie flat on top of the burner heads.
- 8.** Re-install the burner grates in their respective positions.
- 9.** Turn on each burner and check if it operates properly. After verifying that a burner operates normally, turn it off.

---

## Burner caps and heads

---

### NOTES

Before removing the burner caps and heads, remember their size and location. Replace them in the same location after cleaning.

Wash burner caps and burner heads in hot, soapy water and rinse with clean running water. You may scour with a plastic scouring pad to remove burned-on food particles.

Use a sewing needle or twist tie to unclog the small holes in the burner head, if required.

### CAUTION

- Do not wash any burner parts in a dishwasher.
- Do not use steel wool or scouring powders to clean the burners.

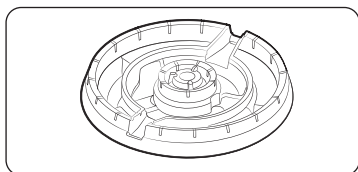

Brass burner head  
(Only NA30N7755T\*/NA36N7755T\*)

### NOTE

- The brass parts of your burner will change color with use. However, this will not affect performance. You can clean the brass parts with a brass cleaner.
- After cleaning, confirm that the burner port openings aren't plugged.

---

## Burner bases

---

### CAUTION

The burner bases cannot be removed for cleaning.

Make sure that no water gets into the burner bases and the brass gas orifices. Wipe clean with a damp cloth. Be careful not to scratch, deform, or damage the bases. Allow them to dry fully before using.

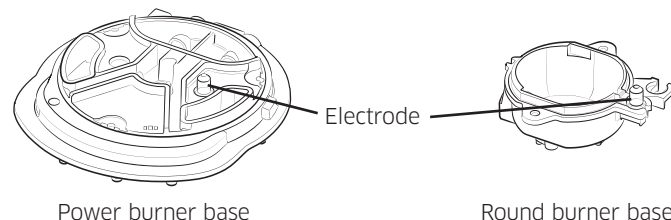

Power burner base

Round burner base

# Care and cleaning of the cooktop

## Electrodes

### ⚠ CAUTION

Do not attempt to remove the electrode from the cooktop or burner bases.

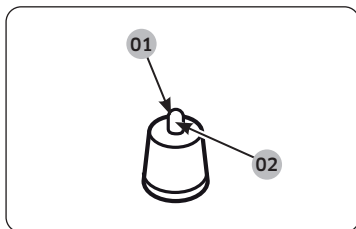

- 01 Clean this metal part
- 02 Do not clean this white ceramic part with an emery board

Be careful not to push in any cooktop controls while cleaning the cooktop. A slight electrical shock might result which could cause you to knock over hot cookware. Make sure that the white ceramic electrodes in the cooktop are clear of soil and dry. Clean the metal part of the electrode with a soft cloth. Do not use water to clean the igniters.

Before reassembling the surface burners, push down gently on each of the white ceramic electrodes to make sure they are pressed against the burners bases.

### 📄 NOTE

Do not attempt to remove the electrode from the cooktop.

## Grates and wok grate

### ⚠ CAUTION

Do not clean the grates or wok grate in a dishwasher. They will be damaged.

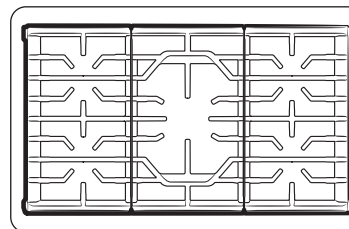

Lift grates out when cool. Grates should be washed regularly and after spillovers. Wash them in hot, soapy water and rinse with clean water. When replacing the grates, be sure they are positioned securely over the burners.

## Cast-iron griddle (for NA30N7755T\*/NA36N7755T\* only)

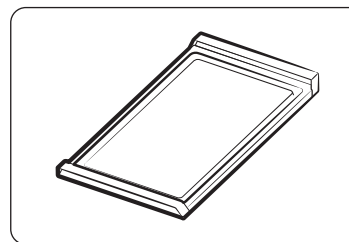

- Rinse with hot water (do not use soap), and dry thoroughly.
- Before cooking, prepare the surface with cooking spray or vegetable oil.
- After cooking, clean the griddle with a stiff brush and hot water.
- Using soap is not recommended and harsh detergents should never be used.
- Store in a cool, dry place.

### ⚠ CAUTION

- If something has spilled under the griddle, it should be cleaned up as soon as possible to prevent "baked on" food soil.
- Do not allow grease to accumulate under the griddle as it can be a fire hazard. Clean under the griddle as soon as it is cool with hot soapy water.
- Do not place the griddle in a microwave.
- Do not wash in a dishwasher.
- Always turn off all surface burners before removing the griddle. Use caution when handling a hot griddle.
- Do not clean the griddle in a self-cleaning oven.

## Burner head and cap replacement

### Dual Burner head

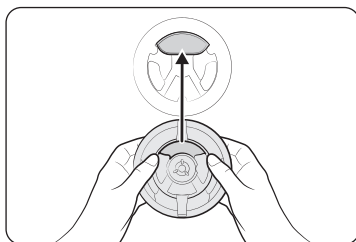

1. Orient the burner head so that the opening for the electrode lines up with the electrode.

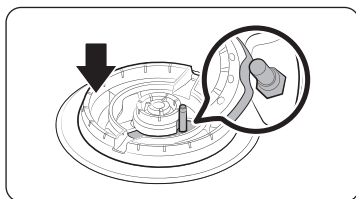

2. Install the burner head so that the electrode passes through the opening for the electrode. Make sure the burner head lies flat on the stove top.

### Round Burner head

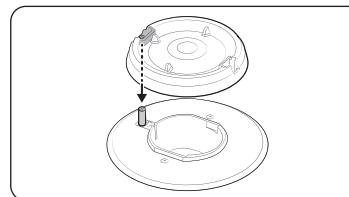

1. Orient the burner head so that the opening for the electrode lines up with the electrode.

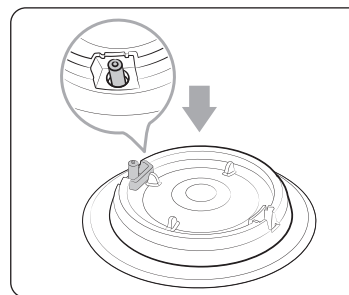

2. Install the burner head so that the electrode passes through the opening for the electrode. Make sure the burner head lies flat on the stove top.

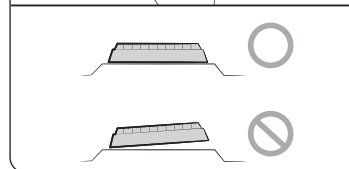
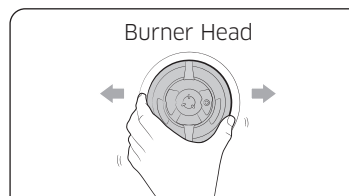

### **⚠ CAUTION**

Make sure all burner components (heads and caps) are reinstalled properly. They will be stable and rest flat when correctly installed.

# Care and cleaning of the cooktop

## Burner cap

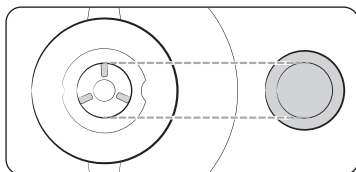

Match the burner caps to the burners by size, and then re-install the caps on the burner heads.

### ⚠ CAUTION

Make sure each cap is re-installed on the correct burner head, is centered on the burner head, and lies flat.

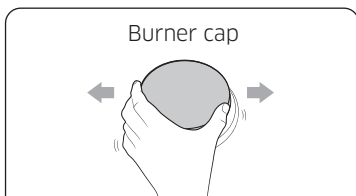
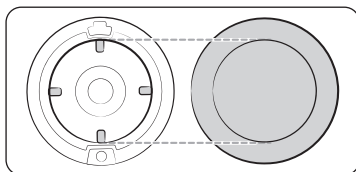
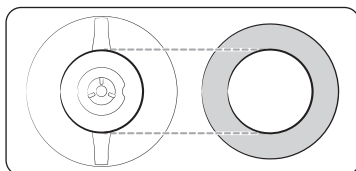

Burner cap

### ⚠ CAUTION

Make sure all burner components (heads and caps) are reinstalled properly. They will be stable and rest flat when correctly installed.

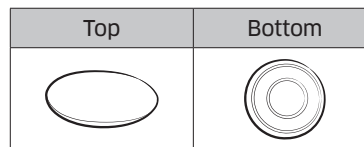
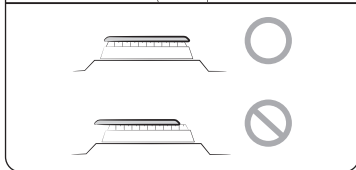

### 📖 NOTE

The precise simmer burner (RR) cap and the inner Dual burner (Center) cap are interchangeable.

### 📖 NOTE

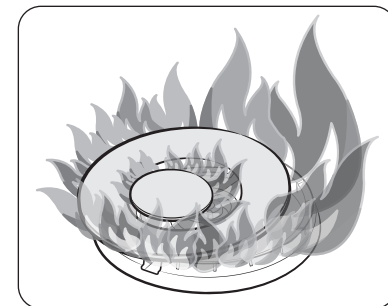
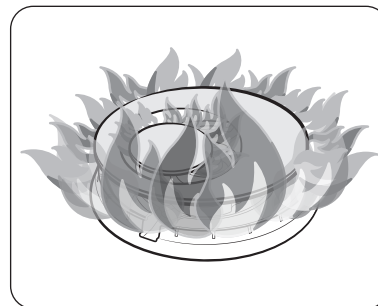
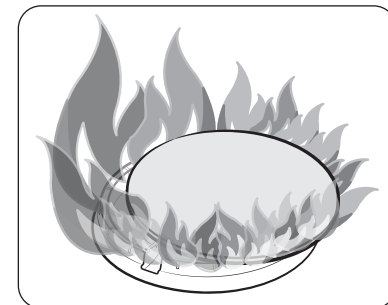
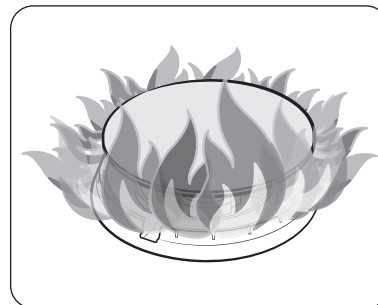

After installation of surface burners, check the ignition. Incorrect placement of a burner head or cap will result in poor ignition or uneven flames (as shown in the pictures).

# Troubleshooting

If you encounter a problem with the cooktop, check the tables starting below, and then try the suggested actions.

## Checkpoints

### Gas safety

Problem	Possible cause	Action
You smell gas.	The surface burner knob is not in the <b>OFF</b> position and the burner is not lit.	Turn the burner knob to <b>OFF</b> .
	There is a gas leak.	Clear the room, building, or area of all occupants. Immediately call your gas supplier from a neighbor's phone. Do not call from your phone. It is electrical and could cause a spark that could ignite the gas. Follow the gas supplier's instructions. If you cannot reach your gas supplier, call the fire department.

### Surface burner

Problem	Cause	Action
All burners do not light.	The power cord is not plugged into the electrical outlet.	Make sure the electrical plug is plugged into a live, properly grounded outlet.
	A fuse in your home may be blown or the circuit breaker may have tripped.	Replace the fuse or reset the circuit breaker.
	The gas supply is not properly connected or turned on.	See the Installation Instructions that came with your cooktop.

Problem	Cause	Action
Surface burners do not light.	The control knob is not set properly.	Push in the control knob and turn it to the Lite position.
	The burner caps are not in place. The burner base is misaligned.	Clean the electrodes. Put the burner cap on the burner head. Align the burner base.
A surface burner clicks during operation.	The control knob has been left in the Lite position.	After the burner lights, turn the control knob to a desired setting. If the burner still clicks, contact a service technician.
The burners do not burn evenly.	Surface burner components and caps are not assembled correctly and level.	pages <b>22</b> , <b>23</b> , and <b>24</b> .
	The surface burners are dirty.	Clean the surface burner components. (pages <b>20</b> , <b>21</b> , and <b>22</b> .)
Very large or yellow surface burner flames.	The wrong burner orifice is installed.	Check the burner orifice size. Contact your installer if you have the wrong orifice (LP gas instead of natural gas or natural gas instead of LP gas).

# Warranty (U.S.A)

**PLEASE DO NOT DISCARD. THE PAGE REPLACES THE WARRANTY PAGE IN THE USE & CARE GUIDE**

## **SAMSUNG GAS RANGE / COOKTOP**

### **LIMITED WARRANTY TO ORIGINAL PURCHASER WITH PROOF OF PURCHASE**

This SAMSUNG brand product, as supplied and distributed by SAMSUNG ELECTRONICS AMERICA INC. (SAMSUNG) and delivered new, in the original carton to the original consumer purchaser, is warranted by SAMSUNG against manufacturing defects in materials or workmanship for the limited warranty period, starting on the date of delivery to the original consumer purchaser, of:

#### **One (1) Year Parts and Labor**

This limited warranty is valid only on products purchased and used in the United States that have been installed, operated, and maintained according to the instructions attached to or furnished with the product. To receive warranty service, the purchaser must contact SAMSUNG at the address or phone number provided below for problem determination and service procedures. Warranty service can only be performed by a SAMSUNG authorized service center. The original dated bill of sale and/or proof of delivery must be presented upon request as proof of purchase to SAMSUNG or SAMSUNG's authorized service center to receive warranty service.

SAMSUNG will provide in-home service within the contiguous United States during the warranty period at no charge, subject to availability of SAMSUNG authorized servicers within the customer's geographic area. If in-home service is not available, SAMSUNG may elect, at its option, to provide transportation of the product to and from an authorized service center. If the product is located in an area where service by a SAMSUNG authorized servicer is not available, you may be responsible for a trip charge or required to bring the product to a SAMSUNG authorized service center for service.

To receive in-home service, product must be unobstructed and accessible to the service agent.

During the applicable warranty period, a product will be repaired, replaced, or the purchase price refunded, at the sole option of SAMSUNG. SAMSUNG may use new or reconditioned parts in repairing a product, or replace the product with a new or reconditioned product. Replacement parts and products are warranted for the remaining portion of the original product's warranty or ninety (90) days, whichever is longer. All replaced parts and products are the property of SAMSUNG and you must return them to SAMSUNG.

This limited warranty covers manufacturing defects in materials or workmanship encountered in normal household, noncommercial use of this product and shall not cover the following: damage that occurs in shipment, delivery, installation, and uses for which this product was not intended; damage caused by unauthorized modification or alteration of the product; product where the original factory serial numbers have been removed, defaced, changed in any way, or cannot be readily determined; cosmetic damage including scratches, dents, chips, and other damage to the product's finishes; damage caused by abuse, misuse, pest infestations, accident, fire, floods, or other acts of nature or God; damage caused by use of equipment, utilities, services, parts, supplies, accessories, applications, installations, repairs, external wiring or connectors not supplied or authorized by SAMSUNG; damage caused by incorrect electrical line current, voltage, fluctuations and surges; damage caused by failure to operate and maintain the product according to instructions; in-home instruction on how to use your product; and service to correct installation not in accordance with electrical or plumbing codes or correction of household electrical or plumbing (i.e., house wiring, fuses, or water inlet hoses). In addition, damage to the glass cooktop caused by (i) use of cleaners other than the recommended cleaners and pads or (ii) hardened spills of sugary materials or melted plastic that are not cleaned according to the directions in the use and care guide are not covered by this limited warranty.

The cost of repair or replacement under these excluded circumstances shall be the customer's responsibility.

Visits by an authorized servicer to explain product functions, maintenance or installation are not covered by this limited warranty. Please contact SAMSUNG at the number below for assistance with any of these issues.

---

## EXCLUSION OF IMPLIED WARRANTIES

IMPLIED WARRANTIES, INCLUDING THE IMPLIED WARRANTIES OF MERCHANTABILITY OR FITNESS FOR A PARTICULAR PURPOSE, ARE LIMITED TO ONE YEAR OR THE SHORTEST PERIOD ALLOWED BY LAW. Some states do not allow limitations on how long an implied warranty lasts, so the above limitations or exclusions may not apply to you. This warranty gives you specific rights, and you may also have other rights, which vary from state to state.

## LIMITATION OF REMEDIES

YOUR SOLE AND EXCLUSIVE REMEDY IS PRODUCT REPAIR, PRODUCT REPLACEMENT, OR REFUND OF THE PURCHASE PRICE AT SAMSUNG'S OPTION, AS PROVIDED IN THIS LIMITED WARRANTY. SAMSUNG SHALL NOT BE LIABLE FOR SPECIAL, INCIDENTAL OR CONSEQUENTIAL DAMAGES, INCLUDING BUT NOT LIMITED TO TIME WAY FROM WORK, HOTELS AND/OR RESTAURANT MEALS, REMODELING EXPENSES, LOSS OF REVENUE OR PROFITS, FAILURE TO REALIZE SAVINGS OR OTHER BENEFITS REGARDLESS OF THE LEGAL THEORY ON WHICH THE CLAIM IS BASED, AND EVEN IF SAMSUNG HAS BEEN ADVISED OF THE POSSIBILITY OF SUCH DAMAGES. Some states do not allow exclusion or limitation of incidental or consequential damages, so the above limitations or exclusions may not apply to you. This warranty gives you specific rights, and you may also have other rights, which vary from state to state.

SAMSUNG does not warrant uninterrupted or error-free operation of the product. No warranty or guarantee given by any other person, firm, or corporation with respect to this product shall be binding on SAMSUNG.

To obtain warranty service, please contact SAMSUNG at:

Samsung Electronics America, Inc.  
85 Challenger Road  
Ridgefield Park, NJ 07660  
1-800-SAMSUNG (726-7864) and [www.samsung.com/us/support](http://www.samsung.com/us/support)

---

## Registration

Please register your product online at [www.samsung.com/register](http://www.samsung.com/register).

## Questions

For questions about features, operation/performance, parts, accessories, or service, call 1-800-SAMSUNG (726-7864), or visit our Web site at [www.samsung.com/us/support](http://www.samsung.com/us/support).

Model # \_\_\_\_\_ Serial # \_\_\_\_\_

Please attach your receipt (or a copy) to this manual. You may need it, along with your model and serial number, when calling for assistance.

## Warranty (CANADA)

**PLEASE DO NOT DISCARD.**

**SAMSUNG GAS Cooktop**

**LIMITED WARRANTY TO ORIGINAL PURCHASER**

This SAMSUNG brand product, as supplied and distributed by SAMSUNG ELECTRONICS CANADA INC. (SAMSUNG) and delivered new, in the original carton to the original consumer purchaser, is warranted by SAMSUNG against manufacturing defects in materials and workmanship for a limited warranty period of:

### **One (1) Year Parts and Labor**

This limited warranty begins on the original date of purchase, and is valid only on products purchased and used in the Canada. To receive warranty service, the purchaser must contact SAMSUNG for problem determination and service procedures. Warranty service can only be performed by a SAMSUNG-authorized service center, and any unauthorized service will void this warranty. The original dated bill of sale must be presented upon request as proof of purchase to SAMSUNG or SAMSUNG's authorized service center. Samsung will provide in-home service during the one (1) year warranty period at no charge subject to availability within the contiguous Canada. In-home service is not available in all areas. To receive in-home service, product must be unobstructed and accessible to the service agent. If service is not available, Samsung may elect to provide transportation of the product to and from an authorized service center.

SAMSUNG will repair or replace this product, at our option and at no charge as stipulated herein, with new or reconditioned parts or products if found to be defective during the limited warranty period specified above. All replaced parts and products become the property of SAMSUNG and must be returned to SAMSUNG. Replacement parts and products assume the remaining original warranty, or ninety (90) days, whichever is longer.

This limited warranty shall not cover cases of incorrect electric current, voltage or supply, light bulbs, house fuses, house wiring, cost of a service call for instructions, or fixing installation errors. Furthermore, damage to the cooktop caused by the use of cleaners other than the recommended cleaners and pads and damage to the cooktop caused by hardened spills of sugary materials or melted plastic that are not cleaned according to the directions in the use and care guide are not covered. SAMSUNG does not warrant uninterrupted or error-free operation of the product.

EXCEPT AS SET FORTH HEREIN, THERE ARE NO WARRANTIES OR CONDITIONS ON THIS PRODUCT EITHER EXPRESS OR IMPLIED AND SAMSUNG DISCLAIMS ALL WARRANTIES AND CONDITIONS INCLUDING, BUT NOT LIMITED TO, ANY IMPLIED WARRANTIES AND CONDITIONS OF MERCHANTABILITY, INFRINGEMENT, OR FITNESS FOR A PARTICULAR PURPOSE. NO WARRANTY OR GUARANTEE GIVEN BY ANY PERSON, FIRM, OR CORPORATION WITH RESPECT TO THIS PRODUCT SHALL BE BINDING ON SAMSUNG. SAMSUNG SHALL NOT BE LIABLE FOR LOSS OF REVENUE OR PROFITS, FAILURE TO REALIZE SAVINGS OR OTHER BENEFITS, OR ANY OTHER GENERAL, INDIRECT, SPECIAL, INCIDENTAL, OR CONSEQUENTIAL DAMAGES CAUSED BY THE USE, MISUSE, OR INABILITY TO USE THIS PRODUCT, REGARDLESS OF THE LEGAL THEORY ON WHICH THE CLAIM IS BASED, AND EVEN IF SAMSUNG HAS BEEN ADVISED OF THE POSSIBILITY OF SUCH DAMAGES. NOR SHALL RECOVERY OF ANY KIND AGAINST SAMSUNG BE GREATER IN AMOUNT THAN THE PURCHASE PRICE OF THE PRODUCT SOLD BY SAMSUNG AND CAUSING THE ALLEGED DAMAGE. WITHOUT LIMITING THE FOREGOING, PURCHASER ASSUMES ALL RISK AND LIABILITY FOR LOSS, DAMAGE, OR INJURY TO PURCHASER AND PURCHASER'S PROPERTY AND TO OTHERS AND THEIR PROPERTY ARISING OUT OF THE USE, MISUSE, OR INABILITY TO USE THIS PRODUCT. THIS LIMITED WARRANTY SHALL NOT EXTEND TO ANYONE OTHER THAN THE ORIGINAL PURCHASER OF THIS PRODUCT, IS NONTRANSFERABLE, AND STATES YOUR EXCLUSIVE REMEDY.

---

Some states or provinces do not allow limitations on how long an implied warranty lasts, or the exclusion or limitation of incidental or consequential damages, so the above limitations or exclusions may not apply to you.

This warranty gives you specific legal rights, and you may also have other rights which vary from state to state or province to province.

To obtain warranty service, please contact SAMSUNG at:

<p style="text-align: center;">Samsung Electronics Canada Inc. 2050 Derry Road West, Mississauga, Ontario L5N 0B9 Canada 1-800-SAMSUNG (726-7864) and <a href="http://www.samsung.com/ca/support">www.samsung.com/ca/support</a> (English) <a href="http://www.samsung.com/ca_fr/support">www.samsung.com/ca_fr/support</a> (French)</p>
--

---

## Registration

Please register your product online at [www.samsung.com/register](http://www.samsung.com/register).

## Questions

For questions about features, operation/performance, parts, accessories, or service, call 1-800-SAMSUNG (726-7864), or visit our Web site at [www.samsung.com/ca/support](http://www.samsung.com/ca/support) (English), or [www.samsung.com/ca\\_fr/support](http://www.samsung.com/ca_fr/support) (French).

Model #

Serial #

Please attach your receipt (or a copy) to this manual. You may need it, along with your model and serial number, when calling for assistance.

# Appendix

---

## Open Source Announcement

---

The software included in this product contains open source software. You may obtain the complete corresponding source code for a period of three years after the last shipment of this product by sending an email to <mailto:oss.request@samsung.com>.

It is also possible to obtain the complete corresponding source code in a physical medium such as a CD-ROM; a minimal charge will be required.

The following URL <http://opensource.samsung.com/opensource/SimpleConnectTP/seq/0> leads to the download page of the source code made available and open source license information as related to this product. This offer is valid to anyone in receipt of this information.



## Model name & serial number

---

Both the model name and the serial number are marked right side of the cooktop base. For later use, write down the information onto the current page.

Model Name \_\_\_\_\_

Serial Number \_\_\_\_\_

# Memo

---

Memo

---



Scan this with your smartphone.

Scan the QR code\* or visit [www.samsung.com/spsn](http://www.samsung.com/spsn) to view our helpful How-to Videos and Live Shows  
\*Requires reader to be installed on your smartphone

Please be advised that the Samsung warranty does NOT cover service calls to explain product operation, correct improper installation, or perform normal cleaning or maintenance.

#### QUESTIONS OR COMMENTS?

COUNTRY	CALL	OR VISIT US ONLINE AT
U.S.A Consumer Electronics	1-800-SAMSUNG (726-7864)	<a href="http://www.samsung.com/us/support">www.samsung.com/us/support</a>
CANADA	1-800-SAMSUNG (726-7864)	<a href="http://www.samsung.com/ca/support">www.samsung.com/ca/support</a> (English) <a href="http://www.samsung.com/ca_fr/support">www.samsung.com/ca_fr/support</a> (French)

