

# Use & Care MANUAL



**7 SERIES**  
VDWU724  
FDWU724

**To prevent accidents, which could cause serious injury or death, as well as machine damage read these instructions before installation and / or use.**

Please read this user manual and particularly the safety instructions completely and carefully. They will save you time and effort and help to ensure optimum dishwasher performance.

Contents

<b>1. IMPORTANT SAFETY INSTRUCTIONS</b>	<b>3</b>
2. RECYCLING	4
<b>3. GETTING TO KNOW YOUR DISHWASHER</b>	<b>4</b>
<b>4. LOADING THE DISHWASHER</b>	<b>5</b>
4.1 UPPER RACK	6
4.2 LOWER RACK	7
4.3 PROPER AND IMPROPER LOADING OF YOUR DISHWASHER	9
<b>5. WHAT SHOULD NOT BE WASHED IN YOUR DISHWASHER</b>	<b>9</b>
<b>6. OPERATING THE PRODUCT</b>	<b>10</b>
PROGRAM SELECTION / PROGRAM CANCEL KEY	11
6.1 FUNCTION KEYS	11
6.2 PREPARING THE MACHINE	11
6.3 PROGRAM SELECTION	11
6.4 AUXILIARY FUNCTIONS	11
6.5 SCHEDULING THE WASHING TIME	14
6.6 STARTING THE PROGRAM	14
6.7 CANCELLING THE PROGRAM	14
6.8 RINSE AID INDICATOR (☼)	14
6.9 END OF PROGRAM	15
6.10 WATER CUT-OFF WARNING	15
6.11 OVERFLOWING WARNING	15
<b>7. DETERGENT</b>	<b>15</b>
7.1 ADDING DETERGENT	15
7.2 TABLET DETERGENTS	16
7.3 RINSE AID	16
<b>8. CARE AND MAINTENANCE</b>	<b>17</b>
8.1 CARING FOR YOUR DISHWASHER EXTERIOR	17
8.2 CARING FOR YOUR DISHWASHER INTERIOR	17
8.3 CLEANING THE FILTERS	17
8.4 CLEANING THE WASH ARMS	18
<b>9. TROUBLESHOOTING</b>	<b>19</b>
<b>10. TECHNICAL FEATURES</b>	<b>21</b>
<b>11. WARRANTY</b>	<b>22</b>

Be sure to observe all listed warnings and cautions. Look particularly for the icons with exclamation marks inside. The information icon will also provide important references.

	<b>WARNING:</b> Indicates a potentially hazardous situation which, if not avoided, could result in death or serious injury.
---	---

	<b>CAUTION:</b> Indicates a potentially hazardous situation which, if not avoided, may result in injury. It may also be used to alert against unsafe practices.
---	---

	<b>NOTICE:</b> Indicates a potentially hazardous situation which, if not avoided, may result in damage to the dishwasher, the table-ware, the equipment or the environment.
---	---

# 1. IMPORTANT SAFETY INSTRUCTIONS

	<p><b>WARNING:</b>When using the dishwasher, follow basic precautions, including the following: Read all instructions before using the dishwasher! Save these operating instructions and pass them on to any future user.</p>
---	---

	<p>“This device complies with Part 15 of the FCC Rules. Operation is subject to the following two conditions: (1) this device may not cause harmful interference, and (2) this device must accept any interference received, including interference that may cause undesired operation.”</p> <p>“No changes shall be made to the equipment without the manufacturer’s permission as this may void the user’s authority to operate the equipment”</p>
---	--

- Use the dishwasher only for its intended purpose as described in this user manual. This appliance is intended for normal household use only.
- The manufacturer disclaims responsibility for damage or injury caused by improper use of this appliance.
- The information in this user manual must be followed to minimize the risk of fire or explosion and to prevent property damage, personal injury or loss of life.
- Do not operate your dishwasher unless all the enclosure panels are properly in place.
- Do not tamper with the controls.
- Do not abuse, sit on, stand in or on the door or dish rack of the dishwasher.
- The cup racks are designed to support cups, glasses and kitchen utensils. When the cup racks are in the dishwasher do not lean on or use the cup racks to support your body weight.
- To reduce the risk of injury, do not allow children to play in, on or near the dishwasher.
- Use only detergents or rinse aids recommended for use in a household dishwasher and keep them in a dry place out of the reach of children. Check that the detergent dispenser is empty after the completion of each wash program.
- Dishwasher detergents contain chemicals that can cause sickness and may be if they are inhaled or swallowed. Also, be careful when opening the door due to hot steam that is produced during operation. Consult a doctor immediately if detergent has been swallowed or inhaled.
- if the hot water has not been used in several weeks, we recommend running the hot water taps to remove any built up hydrogen gases.
- Do not store or use flammable liquids or vapors in the area of the dishwasher.
- When loading items to be washed, position sharp items so that they are not likely to damage the door seal and load sharp knives with the handles up to reduce the risk of cut-type injuries.
- Do not wash plastic items unless they are marked “dishwasher safe” or the equivalent. For plastic items not so marked, check

- the manufacturer’s recommendations.
- If a malfunction occurs, switch off the appliance and turn off the water supply to the dishwasher.
- Please do not attempt to carry the dishwasher by yourself in order to avoid potential injuries. Two or more people are needed to move a dishwasher.
- Before cleaning or carrying out maintenance, switch off the appliance, disconnect the power plug and turn off the water supply.
- Repairs and technical modifications must be carried out exclusively by a Authorized technician.
- If the dishwasher is not in use for an extended period of time (i.e. vacation home), we recommend remove all items from the dishwasher, leave the door cracked open to allow air to circulate and turn off both the power and water supply to the dishwasher.
- This appliance comes with a three prong NEMA 5-15P 15A power cord. It must be connected to a Grounded and Polarized wall receptacle that has been installed and tested by an licensed electrician and that it has been installed based on all Local, State and Federal Electrical codes.

	<p><b>WARNING:</b>Improper connection of the equipment-grounding conductor can result in a risk of electric shock. Check with a qualified electrician or service representative if you are in doubt whether the appliance is properly grounded. Do not modify the plug provided with the appliance, if it will not fit the outlet, have a proper outlet installed by a qualified electrician.</p>
---	---

- This appliance produces ozone within the washing compartment during normal operation. Long-term exposure to ozone or exposure at elevated levels may result in respiratory problems, especially for the infirmed, elderly and children.
- Children should not operate this machine without adult supervision.
- Be Careful to not leave the door fully open when not being loaded or unloaded to prevent someone from tripping on the unit.

	<p><b>WARNING:</b> Lamp should only be replaced by the Authorized Service Agent in case of failures that may occur on the lamp.</p>
---	---

	<p><b>WARNING:</b> This product can expose you to chemicals including Nickel (Metallic) which is known to the State of California to cause cancer.</p> <p>For more information go to <a href="http://www.P65Warnings.ca.gov">www.P65Warnings.ca.gov</a></p> <p>Note: Nickel is a component in all stainless steel and some other metal components.</p>
---	--

**SAVE THESE INSTRUCTIONS**

- Service should be performed by a qualified installer. Work by unqualified persons could be dangerous and may void the warranty.
- Do not operate the appliance if damaged, malfunctioning, partially disassembled or if it has missing or broken parts.
- Before installation or service, disconnect the power supply to the work area by unplugging the unit, "tripping" the circuit breaker or removing the fuse.
- For safety reasons, dishwasher must be secured to adjacent cabinetry using the brackets provided. Failure to do this may cause damage to property or bodily injury.
- Do not use any extension cord or portable outlet device to connect the dishwasher to a power supply.

## 2. RECYCLING

- Remove the door to the washing compartment when removing an old dishwasher from service or discarding it. Ensure that the appliance presents no danger to children while being stored for disposal.
- Remove the door lock or door of the washing compartment before disposing of dishwasher so that children or small animals can not be trapped inside.
- Old appliances may contain materials that can be recycled. Please contact your local recycling authority about the possibility of recycling these materials.
- Please check the water supply line periodically. It is susceptible to breakage. It becomes less flexible as time goes by. Replace it immediately when it is torn, cut, swollen or there is water leakage.
- Please keep the dishwasher package out of the reach of children after unpacking it.



**WARNING:** Danger of suffocation! Ensure that any plastic wrappings, bags, small pieces etc. are disposed of safely and kept out of the reach of children.

## 3. GETTING TO KNOW YOUR DISHWASHER

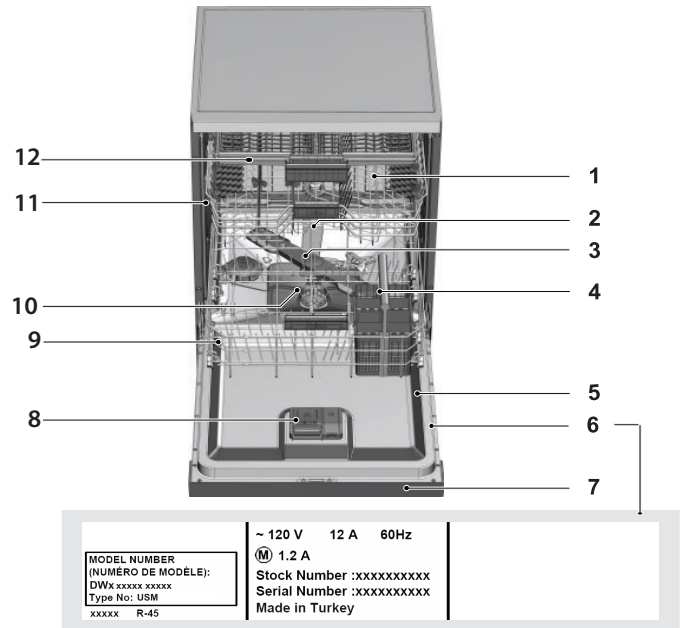

1. Upper basket
2. Upper wash arm
3. Lower wash arm
4. Cutlery basket
5. Door
6. Model and Serial Tag
7. Control panel
8. Detergent and rinse aid dispenser
9. Lower basket
10. Filters
11. Upper basket rail
12. Upper cutlery basket

## 4. LOADING THE DISHWASHER

1. Pull the handle to open the door. If the door is opened during operation, the dishwasher will stop running. Once the door is closed the program will continue.
2. Remove coarse food leftovers from tableware.
3. Now you can load the dishwasher.

12 place setting loading pattern for daily, regular or typical use

### Upper rack



### Lower rack

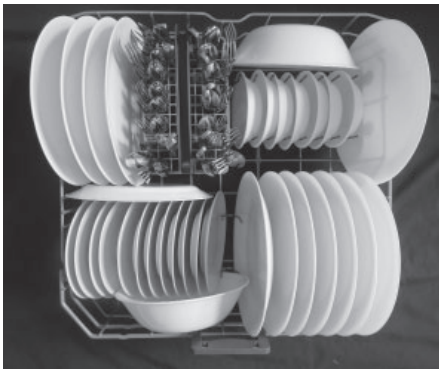

### Upper cutlery basket

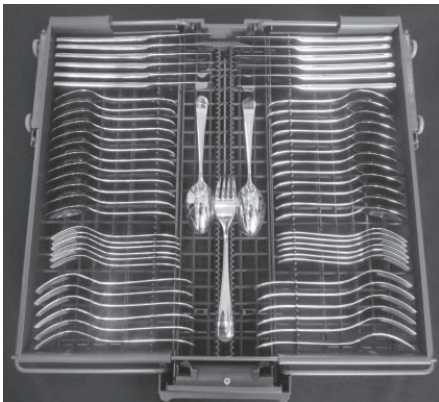

### Cutlery basket

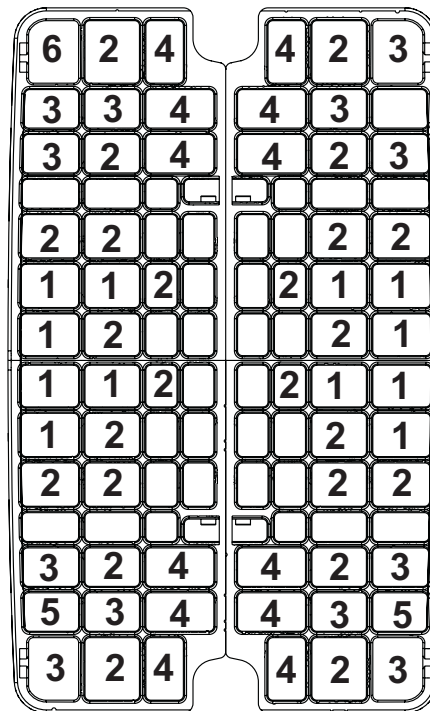
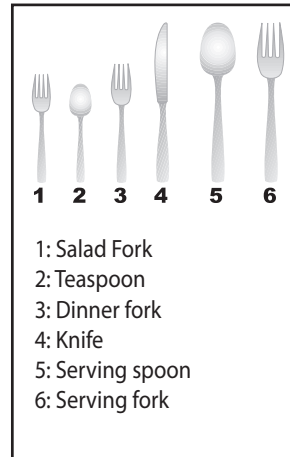

**CAUTION:** Large knives and other utensils with sharp tips and edges must be placed horizontally into the upper rack due to risk of injury. Other smaller knives and sharp utensils should be placed with sharp side down in the cutlery basket.



**CAUTION:** Use extreme caution when removing knives and other sharp utensils from the dishwasher. These items may have shifted position during the wash program, and may be wet or slippery.

**Additional loading pattern for 10 place setting**

**Upper rack**

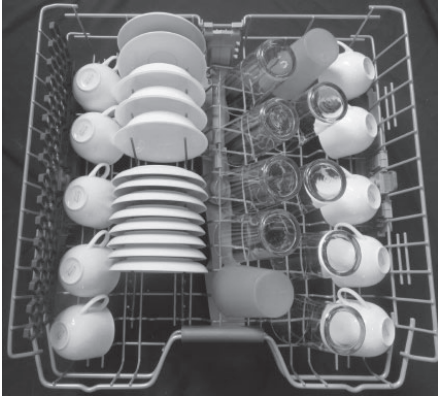

**Lower rack**



**Upper cutlery basket**

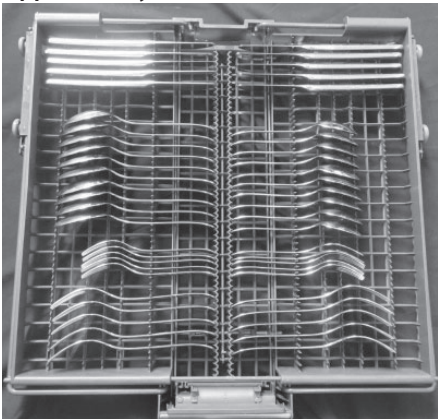

**Upper rack without upper cutlery basket**



**Lower rack without upper cutlery basket**



**CAUTION:** Hot steam can escape! Danger of serious burns or other injury.

- Place all containers such as cups, glasses and pots into the dishwasher with the opening facing downwards (so that no water can collect).
- Small and light items can go into the upper rack.
- Long and narrow items are placed in the middle of the racks.
- Place all large and very dirty items in the lower rack.
- Load dishes accordingly and be careful when loading glasses so they do not hit each other during the wash cycle. Also, make sure that both wash arms are not in contact with any dishware.
- Do not overload your dishwasher and pay attention to manufacturer instructions regarding dishes which are appropriate for use in for a dishwasher. Only with suitable dishes (mentioned in section 5) will you obtain optimal washing results with a sensible use of energy.

**4.1 UPPER RACK**

Load the upper rack with dessert plates, cups, glasses etc.

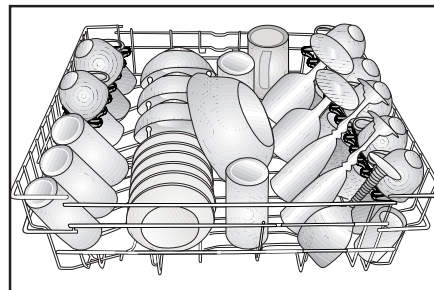

**ADJUSTABLE SHELVES**

Depending on the size of the glasses and cups, the shelf height setting may be adjusted.

1. Fold the shelf upwards **A**.
2. Positioning at the desired height **B**.
3. Fold the shelf again downwards **C**

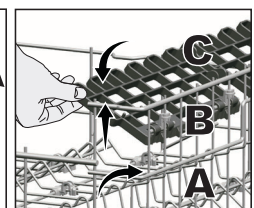
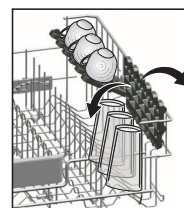

## COLLAPSIBLE UPPER BASKET WIRES

You can use collapsible wires when you need a larger space for your dishes in the upper basket of your machine.

To bring the collapsible wires into horizontal position, grab the wire from the middle position and push them in the direction of arrow in the figure. Place your larger dishes into the area created. To bring the wires back to vertical position, just lift them up.

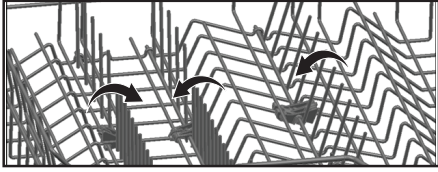

Bringing the wires to the horizontal position by holding them from the tips may cause them to bend. Therefore, hold the wires from their stems while bringing them to the horizontal or vertical positions.

## ADJUSTING THE HEIGHT OF THE UPPER BASKET

The upper basket height adjustment mechanism has been designed for you to create large spaces in the lower or upper sections of your machine depending on your needs by adjusting the height in the upper or lower direction while your basket is empty or loaded.

Thanks to this mechanism, you can use your basket in three different positions, namely lower, middle and upper positions (1, 2, 3).

1. To raise your basket, hold the upper basket wires with both hands while the basket is in the lowermost position and pull them up (A).
2. You will hear a "Click" from the right and left mechanisms, indicating that the basket has reached the next level. Release the basket.

Repeat the process if the height is not sufficient.

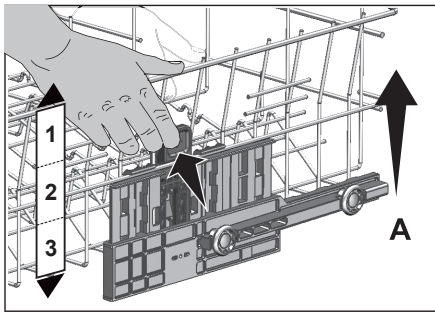

To lower the basket, while it is in the uppermost position;

1. Hold the upper basket wires with both hands, slightly lift up the basket and simultaneously push and release the latches shown in the figure (B).
2. Lower the basket from its current position to the lower one.
3. Release the basket after it has reached one level down.

Repeat the process if the height is not sufficient.

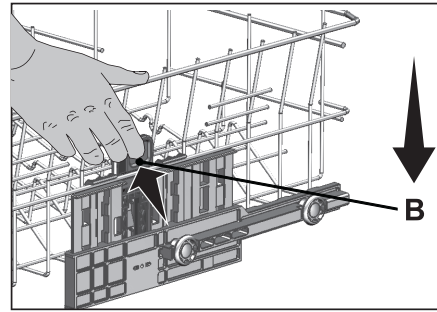

The movement mechanism may not function properly if the upper basket is overloaded or if the weight distribution is not balanced. In heavier conditions, there is the risk of falling one level down.



Make sure that the adjustment mechanism has the same positions on the right and left sides of the upper basket.

## 4.2 LOWER RACK

### COLLAPSIBLE LOWER BASKET TINES

There are foldable tines (A) located at the lower basket of the machine are designed for an easier placement of large pieces such as pans, bowls, etc. You can create larger spaces by folding each tines individually or all of them at once.

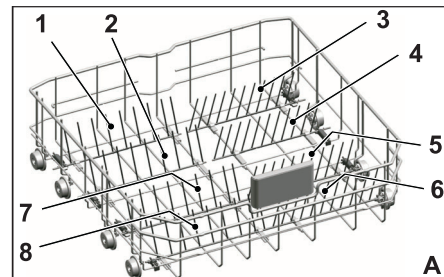

To bring the collapsible tines into horizontal position, grab the tines from mid position and push them in the directions of arrows (B). To bring the tines back to vertical position, just lift them up. Collapsible tines will click into the latch again (C).



### SILVERWARE BASKET

Silverware basket is designed to wash your dishes such as knife, fork, spoon, etc. in a cleaner manner. Since the cutlery basket can be moved (A, B), you can create a wider space while placing your dishes to the lower basket and free up space for your dishes in different sizes.

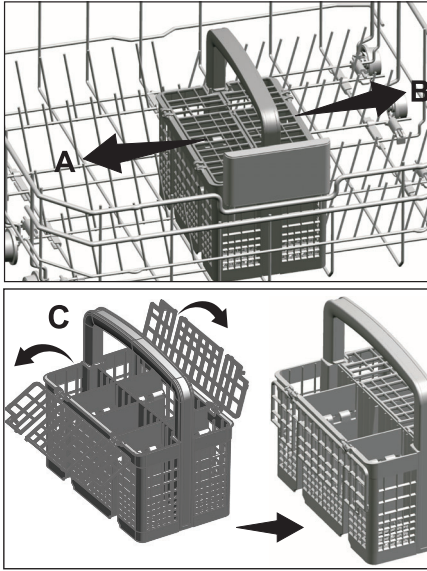

**i** **NOTICE:** When finished, test to ensure that the spray arm can still move freely.

### LOWER BASKET GLASS HOLDER

Lower Basket Glass Holder found in the lower basket of your machine enables a safe washing for your oversized and tall glasses.

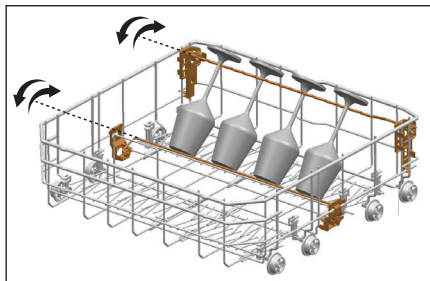

### TRAY WASH SUPPORTS

Use the supports to wash trays in the bottom basket. See the Auxiliary functions section for appropriate program and function selection.

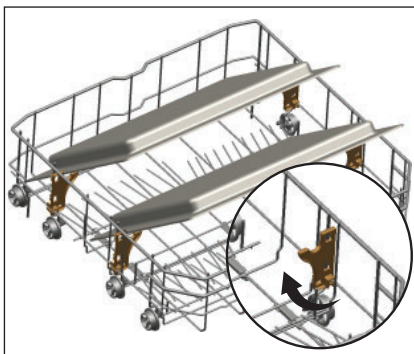

### LOWER BASKET MULTIPURPOSE / HEIGHT ADJUSTABLE SERVICE RACK

This accessory located at the lower basket of your machine allows you to easily wash pieces such as extra glasses, long ladles and bread knives.

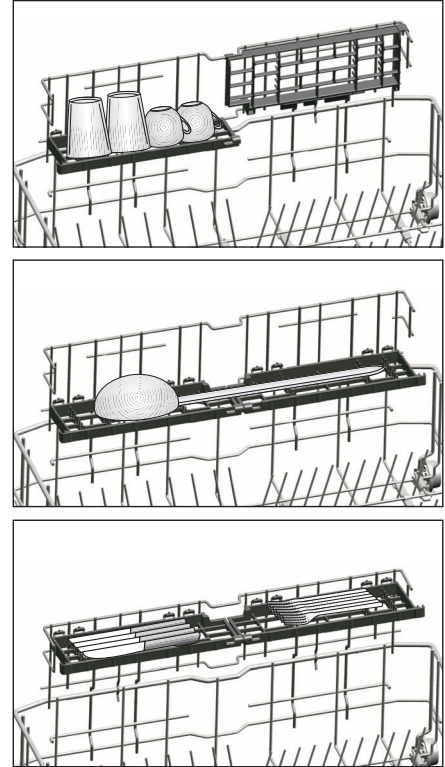

**i** You may use the racks as required by moving them to lower or upper position, or close them to create a wider space in your lower basket.

**!** Make sure that the impeller does not touch the dishes you placed on the racks.

### CEILING CUTLERY BASKET

Ceiling cutlery basket is designed to wash your cutlery items such as forks, spoons and etc. by placing them between the bars on the basket.

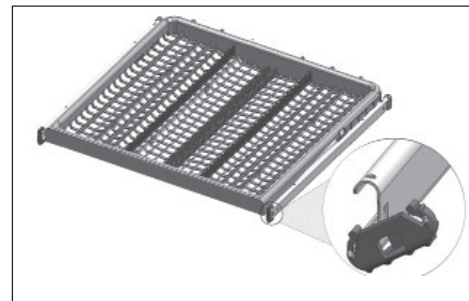

### 4.3 PROPER AND IMPROPER LOADING OF DISHWARE

- Place all containers such as cups, glasses and pots into the dishwasher with the opening facing downwards (so that no water can collect).
- The movement of the spray arms must not be hindered.
- Do not overload your dishwasher.
- Only with suitable dishes (mentioned in section 5) will you obtain optimal washing results with a sensible use of energy.

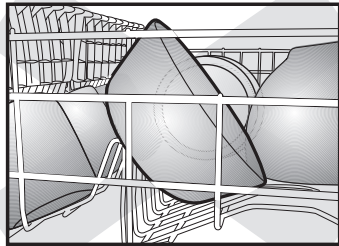

incorrect

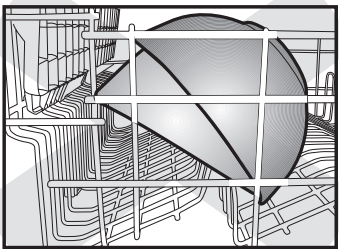

incorrect

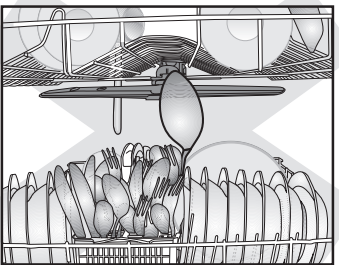

incorrect

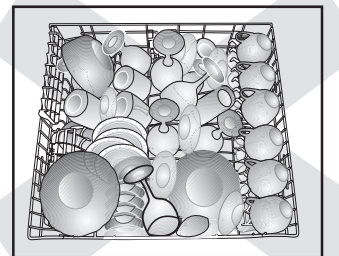

incorrect

### 5. WHAT SHOULD NOT BE WASHED IN YOUR DISHWASHER

- Rust-sensitive steel parts like iron and cast iron that can rust and stain other utensils and damage the interior stainless steel liner of the dishwasher and void the warranty. Do not wash copper, brass, pewter, bronze or tin.
- Cutlery with wooden or horn handles and cutlery with mother-of-pearl or porcelain handles will deteriorate over time if put in the dishwasher.
- Plastics may lose their shape or color with hot water, please follow the instructions of plastic manufacturers. Be sure that plastic items are marked "dishwasher safe".
- Glued dishes or cutlery are not suitable for machine washing since certain adhesives may get soft or dissolve with hot water.
- Aluminum may fade over time. Minerals in water and detergent may cause the aluminum to darken or spot.
- Sterling silver articles should not be washed in the dishwasher because they tend to discolor and become dull by dishwasher detergent.
- Silverware and stainless steel items should not be in contact with each other. Mixing these items can cause staining. Remove and hand dry these items immediately when the program ends.
- Decorated glasses, porcelain, fine china and china with gold rims are sensitive to machine washing. They may lose their patterns and colors over time.
- Crystal and very fine glassware may become opaque (etch) losing their shine over time. You may prefer to wash them by hand.
- Do not wash sponges or dish cloths in dishwasher.
- Do not wash art and craft articles in dishwasher.
- Disposable plastics and disposable aluminum cannot withstand high temperatures; do not wash them in the dishwasher.



**CAUTION:** If in doubt, wash by hand or follow the instructions from the manufacturer of utensils, dishes, glasses or pots and pans. Do not wash items soiled with cigarette ash, candle wax, varnish, paints or chemicals since they can damage your dishwasher.



**NOTICE:** We recommend when buying new dishware, try to choose ones that are suitable for machine washing (marked as dishwasher safe).

#### CARING FOR YOUR TABLE-WARE

The combination of high temperatures and dishwasher detergent may cause damage to some items if they are washed in the dishwasher. Remember, if there is any doubt about any aspect concerning items to be washed in the dishwasher, follow the instructions from the manufacturer of the items, or wash the items by hand.

## 6. OPERATING THE PRODUCT

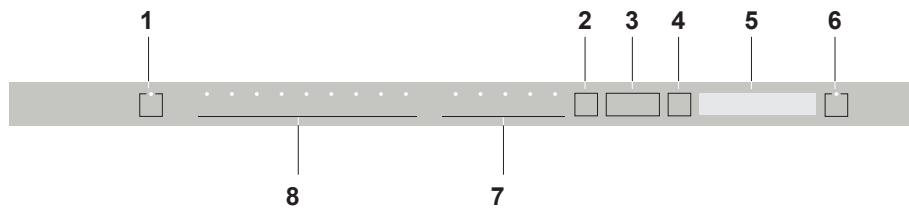

- |                                 |                            |
|---------------------------------|----------------------------|
| 1. On / Off Key                 | 7. Function Selection Keys |
| 2. Menu Key                     | F1 Express Function        |
| 3. Time Delay Selection         | F2 HighGloss Function      |
| / Menu Direction Selection Keys | F3 Sanitize Function       |
| 4. Selection / Confirmation Key | F4 Half Load Function      |
| 5. Display                      |                            |
| 6. Start / Pause / Cancel Key   | 8. Program Selection Keys  |

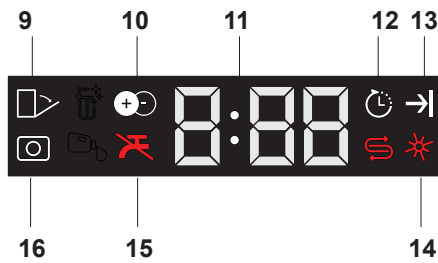

9. Auto Door Open Indicator
10. IonGuard Function Indicator
11. Delay Time / Program Time Indicator
12. Delayed Start Indicator
13. End of Program Indicator
14. Rinse Aid Indicator
15. Water Cut-off Indicator
16. Tablet Detergent Indicator

## On/Off Key

When you press the On/Off key, the indicator lights illuminate on the display for ON position. The lights turn off in OFF position.

## PROGRAM SELECTION / PROGRAM CANCEL KEY

Select the desired program using the "program selection keys" and press the button.

To cancel the running program, open the door of the machine and press and hold the Program Start/Pause/Cancel key for 3 seconds. After the 3 - 2 - 1 countdown, 0:01 is displayed, close the door of the product and wait for the draining process complete. Draining is completed in 2 minutes and the machine gives an audible warning when it is completed.

## 6.1 FUNCTION KEYS

If you press any of the Function keys during program selection or time delay selection, an affirmative key signal will be heard provided that the relevant function is supported by the selected program. Function will be deemed selected when the indicator of the selected function is lit.

To cancel the selected function, keep the function key pressed until the function indicator disappears.

## 6.2 PREPARING THE MACHINE

1. Open the door of the dishwasher.
2. Place the dishes in accordance with the instructions in the user manual.
3. Make sure that the upper and lower impellers rotate freely.
4. Put adequate amount of detergent into the detergent dispenser.

## 6.3 PROGRAM SELECTION

1. Press the On/Off button to turn on your machine.
2. Check the Rinse Aid indicator and add rinse aid if needed.
3. Refer to the table of "Program data and average consumption values" to determine a washing program suitable for your dishes.
4. Selected program will start when you close the door of your machine.



The Energy Guide label and all official certifications are based on 'Normal' soil-sensing cycle as follows: If available on the unit, the automatic detergent detection feature should be deactivated. Dishes should be loaded with the upper rack on its 2nd position and if available third basket should be removed. Tests should be done without any rinse aid in the rinse aid dispenser. Depending on the amount of water taken in preconditioning cycle, calculated amount of detergent according to the definitions in the test procedure should be inserted into the detergent dispenser, without detergent in prewash. For optimal performance with minimum energy consumption, it is recommended to disable all other auxiliary options.

## 6.4 AUXILIARY FUNCTIONS

Washing programs of your dishwasher are designed to obtain the best cleaning effect, considering the type of the soiling, soiling degree and properties of the dishes to be washed.

Auxiliary functions allow you save from time, water and power.



Auxiliary functions may cause changes in the program duration.



Auxiliary functions are not suitable for all washing programs. Indicator of the auxiliary function that is not compatible with the program will not be active.

### Half Load function

It is used to operate the machine without loading it completely.

1. Load your dishes in the machine as you like. You can use both upper and lower racks.
2. Turn the machine on with On/Off key.
3. Select the desired program and press the Half Load key. The Half Load indicator will light on the display in the Function Selected indicator.
4. Close the door of the machine to start the program.

### Express Function

It shortens the time of the washing cycle selected and decreases water consumption by enabling washing under higher pressure.

### HighGloss Function

It provides superior drying performance by increasing rinsing temperature and drying time.

Sanitized indicator

### Sanitize Function

Sanitize function raises the water temperature in the final rinse to meet the requirements of NSF/ANSI STANDARD 184 for Residential Dishwashers. Certified residential dishwashers are not intended for licensed food establishments.



At the end of a successful sanitization "SAN" is displayed on the display. "SAN" is not displayed on the display if the cycle is interrupted or the water could not be heated to the required temperature.



Available programs are indicated on Program Table chart.



Note: Only sanitizing cycles have been designed to meet the requirements of NSF/ANSI Standard 184 for soil removal and sanitization efficacy. There is no intention, either directly or indirectly, that all cycles have passed sanitization performance tests.

Program Data and Average Consumption Values Table								
Program number	1	2	3	4	5	6	7	8
Program name	Auto	Combi Clean	Pots & Pans+	Regular Wash *	GlassCare	Hour Wash	Quick Wash	Rinse & Hold
	Determines the soiling degree of the dishes and sets the temperature and amount of the washing water as well as the washing time automatically. Suitable for all types of dishes.	It is the most suitable washing program for mixed types of dishes including plastic items. While delicate glass items are washed in the upper basket, pans and trays can be washed in the lower basket.	Suitable for very heavily soiled dishes, pots and pans stayed dirty for a time. Cleans at high temperature with higher pressures.	Suitable for regular, daily, or typical use to completely wash and dry a full load of normally soiled dishes.	Special program for gentle cleaning of delicate glassware.	Suitable for cleaning lightly and freshly soiled dishes while saving time.	Suitable for lightly soiled dishes that are scraped or pre-cleaned.	Suitable for removing the remnants on the soiled dishes that will be kept waiting in the machine for a few days, and thus, for preventing the bad odor buildup.
<b>Degree of dirtiness</b>								
	Medium - High	Medium	High	Medium	Few	Few - Medium	Few	-
<b>Wash Temperatures</b>	(°C) 50-55 (°F) 142-157	55 131	70 158	50-55 122-131	45 113	49 120	45 113	0
<b>Rinse Temperatures</b>	(°C) 61-67 (°F) 122-131	66 151	75 167	61-67 142-157	65 149	71 160	55 131	0
<b>Recommended detergent amount</b>	Hard water	25-40	40	25-40	25	25-40	15-25	-
	Medium water	5-8	8	8	5-8	5-8	3-5	-
	Soft water	15-40	40	40	25	25	15	-
<b>Wash</b>	3-8	25-40	25-40	15-25	15	15-25	15	-
	tsp	5-8	5-8	3-5	3	3-5	3	-
<b>Main wash</b>	+	+	+	+	+	-	-	-
<b>Dry</b>	+	+	+	+	+	+	+	+
<b>Sanitize</b>	+	-	+	+	-	-	-	-
<b>Duration (minutes)</b>	100-152	182	122	100-152	101	58	35	15
<b>Water (liters)</b>	9.0-21.2	19.2	20.2	9.0-21.2	13.6	10.4	11.6	4.2
<b>Water (gallons)</b>	2.38-5.55	5.02	5.34	2.38-5.55	3.40	2.70	3.10	1.10
<b>Selectable functions</b>	T, E	T, E, Y, F	T, E, Y, F	T, E	T, E, Y, F	T, E	T, E	-

**Loading Capacity : 16**

The consumption values shown in the table were determined under standard conditions. For this reason, deviations are possible under practical conditions. \* 'Normal' is recommended to completely wash and dry a full load of normally soiled dishes. Energy-usage labeling is based on the 'Normal' cycle.

### Functions Under the Settings Menu

Under the settings menu of your product, there are some additional functions that depend on the model.

To access these functions, press and hold the Menu key for 3 seconds. Use <- and +> to proceed to the desired function or setting. Use the selection key to change the desired function or setting and press the Menu key to exit the Settings menu.

 In some models pressing the Menu key only for once will allow you to enter the Settings menu.

### Submenu Functions:

OpenAir™ Door Opening Function Off/On



Detergent Tablet Function Off/On



Odor Eliminator™ Ionizer Function Off/On



### Tablet detergent function

Allows to obtain a better drying performance from the multi-purpose detergents called as all in one detergents such as 2in1, 3in1, 4in1, 5in1 and etc., depending on the hardness level of the tap water.



If you have used the Tablet features during the last washing program you used, Tablet function will remain active in the next washing program you will select. If you do not want to use these functions in the new program you have selected, press the Tablet Detergent key until the indicator of the relevant function turns off.



Tablet Detergent function may cause change in the program duration.

### Interior Lighting

Interior lighting will illuminate the interior when the door is opened.

### Changing the interior lighting setting

1. After switching on your machine, press the Menu key for 1 second.
2. Press <- and +> to proceed to "L:" on the display. Select the position you want with the Selection key. Interior lighting is off in "L:0" position and on in "L:1" position.
3. Press the Menu key to exit the settings menu. Your setting will be saved automatically.

### Changing Warning Sound Volume

1. After switching on your machine, press the Menu key for 3 second.
2. Press <- and +> to proceed to "S:" on the display.
3. Each pressing on the Selection key will change the warning sound volume as "S:0" off, "S:1" medium and "S:2" high.
4. Press the Menu key to exit the settings menu. Your setting will be saved automatically.

### Floor illumination

#### Illuminates to show program is still running.

Your machine reflects a light to the floor during the washing process. This light turns off after the washing process is complete.



Floor illumination cannot be cancelled by the user.

## 6.5 SCHEDULING THE WASHING TIME

### Time Delay

If an economical electricity tariff is applied in your region, you can use the Time Delay function to wash your dishes during appropriate hours.

You can delay the start of the selected program until 24 hours.

1. Press the Time Delay function key after selecting the washing program and other auxiliary functions.
2. Once you press the Time Delay key, Display Information Line will show "0:30" and Time Delay indicator will start flashing.
3. Set the desired time by pressing the Time Delay key. Time will increase with increments of 30 minutes up to 6 hours and after that in 1 hour increments up to 24 hours every time you press the key.
4. Close the door of your machine after setting the Delayed Start. Once the delay time is over, the selected program will start automatically.

### Changing the settings while Time Delay function is active

While the Time Delay function is activated, you cannot make changes in the washing program, auxiliary functions or the duration of delay time.



Program and auxiliary functions cannot be set/changed after the program has started.

### To cancel the Time Delay function

Open the door of the product Press and hold the Program Selection / Program Cancel keys for 3 seconds. After the 3 - 2 - 1 countdown, 0:01 is displayed, close the door of the product and wait for the draining process complete. Draining is completed in 2 minutes and the machine gives an audible warning when it is completed.



You can select and start a new program following the cancellation of Time Delay function.



Time Delay function cannot be set after the program starts.

## 6.6 STARTING THE PROGRAM

Close the door of your machine to start it after selecting the program and auxiliary functions.



Pay attention not to open the door of the machine when it is running. Use caution when opening the door as steam may have built-up and will escape.



The machine will be switched off if no button is pressed within 5 seconds after opening the door while the machine is running.



After the door has been opened, if any button is pressed within 5 seconds and the door is closed, the selected program resumes; otherwise, the machine will be switched off.  
Open the door after the machine has been switched off, press On/Off button and close the door within 5 seconds. The program will resume washing.

## 6.7 CANCELLING THE PROGRAM

Open the door of the product press and hold the Program Selection / Program Cancel keys for 3 seconds. After the 3 - 2 - 1 countdown, 0:01 is displayed, close the door of the product and wait for the draining process complete. Draining is completed in 2 minutes and the machine gives an audible warning when it is completed.



There might be detergent or rinse aid residue in the machine and/or on the pieces being washed depending on the step the program you have cancelled was in.

## 6.8 RINSE AID INDICATOR (✱)

Please check the rinse aid indicator on the display to see whether there is adequate amount of rinse aid in the dishwasher or not. You need to refill the rinse aid reservoir with rinse aid whenever rinse aid indicator appears on the display of your machine.

### Adjusting the amount of rinse aid

1. After switching on your machine, press the Menu key for 3 second.



In some models pressing the Menu key once will allow you to enter the Settings menu.

2. Using <- and +> keys, proceed to "P:" on the display.
3. Set to the appropriate level with the Selection key.
4. Press the Menu key to exit the settings menu. Your setting will be saved automatically.

No rinse aid dispensed in P:0 wash position.

1 dose of rinse aid is dispensed in P:1 position.

2 doses of rinse aid are dispensed in P:2 position.

3 doses of rinse aid are dispensed in P:3 position.

4 doses of rinse aid are dispensed in P:4 position.

## 6.9 END OF PROGRAM



When the program you have selected comes to an end, an audible warning signal will warn you to turn off your machine. This audible signal will warn you with certain intervals before it turns off.

End of Program indicator will light up when the washing program is over.



For energy saving, the machine is automatically turned off following the completion of the program or if the program is not started.



Leave your dishes in the machine for about 15 minutes to allow them cool down after they are washed. Your dishes will dry in a shorter time if you leave the door of your machine ajar during this period. This process will increase the drying effectiveness of your machine.

## 6.10 WATER CUT-OFF WARNING

If mains water is cut or water inlet tap is turned off the machine cannot take water in and E:02 icon will flash on the program indicator. As long as the problem continues, washing program is paused and the water inlet is checked regularly by the machine; when the water is restored E:02 icon will disappear after a while and the washing program resumes.

## 6.11 OVERFLOWING WARNING

If the machine intakes too much water or there is leakage at any of the components then the machine will detect this and E:01 icon will flash on the Program indicator. As long as the overflowing continues safety algorithm will be active and try to discharge the water. If overflowing stops and safety is assured, E:01 icon will disappear. If E:01 does not disappear, there is a permanent fault. In this case the authorised service should be contacted.

## 7. DETERGENT

You can use powder, liquid/gel or tablet detergents in the machine.



Only use in the machine the detergents produced particularly for use with dishwashers. We recommend you do not use detergents that contain chlorine and phosphate as they are harmful for the environment.

### 7.1 ADDING DETERGENT



Pay attention to the warnings on the detergent packaging to get better washing and drying results. Contact the manufacturer of the detergent for further questions.



Do not put solvents into the detergent dispenser. There is the risk of explosion!

Put the detergent into the detergent dispenser just before operating the machine as illustrated below.

1. Push the latch to right to open the detergent dispenser lid (A).

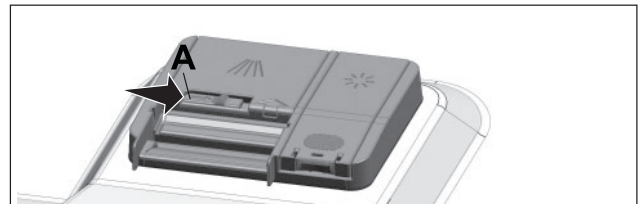

2. Put suggested amount of powder, liquid/gel or tablet detergent in the reservoir.



For suggested amount of detergent; depending on the hardness level of the tap water and the program selected look at Program Table.



Inside the detergent dispenser there are level markings that help you use appropriate amount of powder detergent. When brimful, detergent dispenser will contain 1.5 Ounces (45 cm<sup>3</sup>) of detergent. Fill detergent up to .5 Ounces (15 cm<sup>3</sup>) or .85 ounces (25 cm<sup>3</sup>) level marks in the detergent dispenser according to fullness of the machine and/or soiling degree of the dishes. One tablet is enough if you are using detergent tablets.

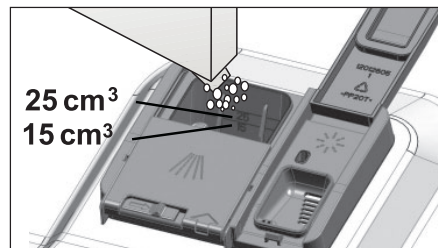

3. Push the lid of the detergent dispenser to close it. A "click" will be heard when the lid is closed.

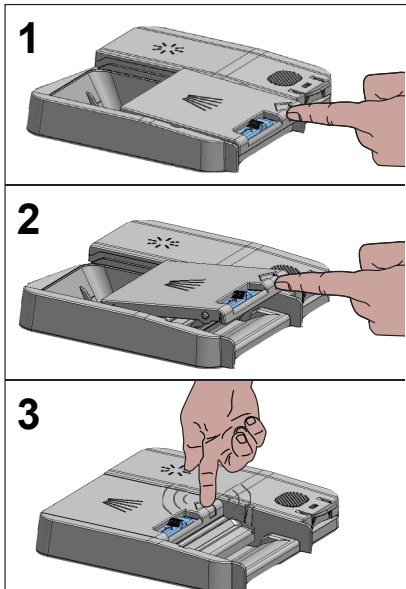

Use powder or liquid/gel detergent in short programs without prewash since the solubility of the tablet detergent changes depending on the temperature and time.

## 7.2 TABLET DETERGENTS

In addition to the conventional tablet detergents, there are also commercially available detergent tablets that show water softening salt and/or rinse aid effect. Some types of these detergents contain special-purpose components such as glass and stainless steel protectors. These tablets show their effects up to a certain water hardness level (59 gpg). Water softening salt and rinse aid must also be used together with the detergent if the water hardness level is above the mentioned level.



The best washing performance in dishwashers is obtained by using detergent, rinse aid and water softening salt individually.

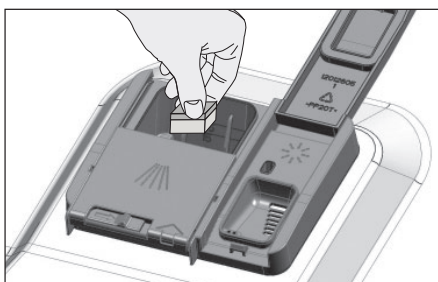

Observe the instructions of the detergent manufacturer on the package when using tablet detergents.



Contact the detergent manufacturer if your dishes are wet and/or if you notice limescale spots particularly on your glasses after the washing program is over when using a tablet detergent.

## When you switch to powder detergent from tablet detergent:

1. Make sure rinse aid reservoir is full.
2. Make the appropriate rinse aid settings.

## 7.3 RINSE AID



The rinse aid used in dishwashers is a special combination that aims to increase drying efficiency and prevent water or lime stains on the washed items. For this reason, care must be paid to have rinse aid in the rinse aid reservoir and to use rinse aids produced specially for dishwashers only.

1. Open the lid of the rinse aid reservoir with the help of the latch.

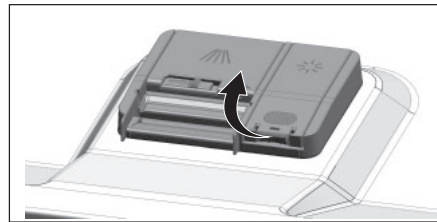

2. Fill the reservoir until "MAX" level.

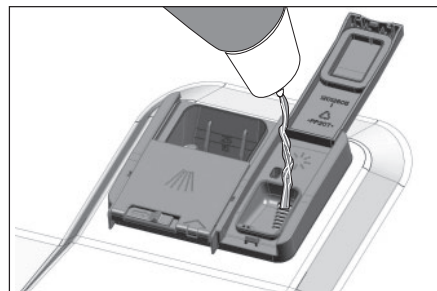

3. Slightly press the point (B) of the reservoir lid to close it.

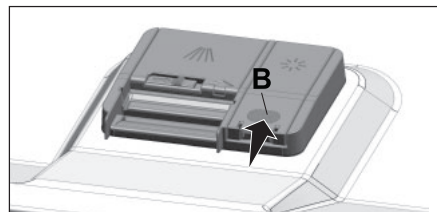

4. If there are stains on tableware items after washing, level must be increased and if there is a blue trace after wiping them by hand, it must be decreased. This is set to position 3 as factory default.



The rinse aid adjustment is described under "Adjusting the amount of rinse aid" in the section for operating the machine.



Wipe clean any spilled rinse aid outside the reservoir. Rinse aid that spilled accidentally will cause foaming and it will eventually decrease washing performance.

## 8. CARE AND MAINTENANCE



**WARNING:** Before cleaning or carrying out maintenance, switch off the appliance, disconnect the main plug and turn off the water tap.



**WARNING:** Do not repair or replace any part of the dishwasher or attempt any servicing unless specifically recommended by this manual. We recommend that the dishwasher only be repaired by an authorized service agent.



**CAUTION:** To avoid the possibility of slipping, keep the floor around the dishwasher clean and dry. Keep your appliance free from the accumulation of combustible materials, such as lint, rags, and chemicals. If the dishwasher is not in use for an extended period of time, we recommend you check that the baskets are empty, leave the inside of the dishwasher clean, the door cracked open to allow air to circulate, turn off both the power and water supply to the dishwasher.

### 8.1 CARING FOR YOUR DISHWASHER EXTERIOR



**CAUTION:** Possible dishwasher damage: Abrasive cleaners, scouring pads, abrasive cloths (paper towels) can damage the dishwasher decorative door.

**Cleaning the control panel:** Use only soft cloth that is lightly dampened with mild detergent. Clean the control panel only with a moist cloth and clear water.

**Cleaning the colored doors:** Use only soft cloth that is lightly dampened with mild detergent.

**Cleaning the stainless steel doors:** Use a soft cloth with a cleaner made for cleaning stainless steel. For the best results, apply the stainless steel cleaner to a soft cloth and wipe the surface in the direction of the grain.

**Cleaning the door gasket:** Regularly clean the door gasket with a damp cloth to remove food particles and other debris. Use a gentle household cleaner for the outside and the door seals, and rinse thoroughly.

### 8.2 CARING FOR YOUR DISHWASHER INTERIOR



**NOTICE:** Cleaning your dishwasher at regular intervals ensures longer product life and reduces the risk of recurring problems. Always disconnect the power to machine before cleaning.



**CAUTION:** When cleaning the underside of the main filter, care must be taken on the sharp outer edge to avoid the risk of cut type injuries.

### 8.3 CLEANING THE FILTERS

Clean the filters at least once a week in order for the machine operates efficiently. If there is food residue on filters, take them out and clean well under running water

1. Turn the micro filter (1) and coarse filter (2) assembly counterclockwise and pull it out from its seating.

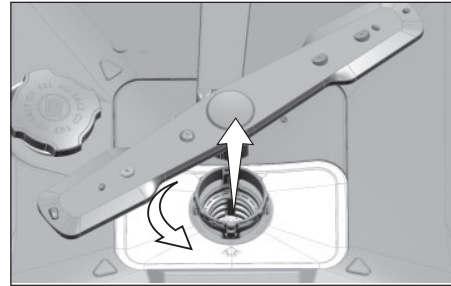

2. Pull out the metal / plastic filter (3) from the seating.

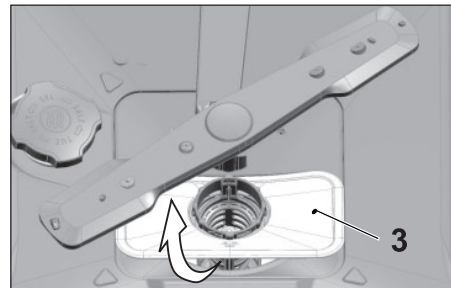

3. Press the two pawls on the coarse filter inwards and separate the coarse filter from the assembly.

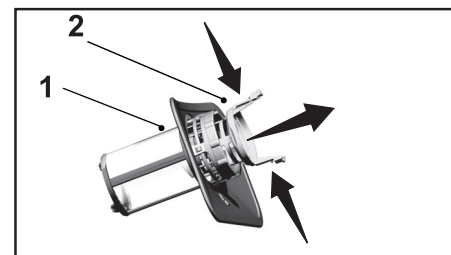

4. Clean all three filters under tap water by means of a brush.
5. Replace the metal/plastic filter.
6. Place the coarse filter into the microfilter. Make sure that it is properly seated. Turn the coarse filter clockwise until a "click" sound is heard.



Do not use the dishwasher without filter.



Incorrect placement of the filters will reduce washing efficiency.

## 8.4 CLEANING THE WASH ARMS

Clean the impellers at least once a week in order for the machine operates efficiently.

### LOWER WASH ARMS

Check if the holes on the lower impeller (1) are clogged. If they are clogged, remove and clean the wash arm. You can pull the lower wash arm up to remove it.

### UPPER WASH ARMS

Check if the holes on the upper wash arm (1) are clogged. If they are clogged, remove and clean. Turn the nut to left to remove the upper wash arm.

Make sure that the nut is tightened well when reinstalling the upper wash arm.

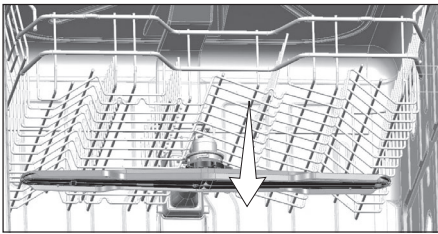
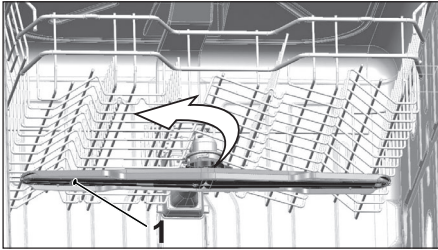

## 9. TROUBLESHOOTING

### Machine does not start.

- Power cable is unplugged. >>> Check if the power cable is plugged in.
- Circuit Breaker is blown. >>> Check the circuit breaker in your house.
- Water is off. >>> Make sure that the water inlet tap is open.
- Door of the machine is open. >>> Make sure that you have closed the door of the machine.
- On / Off button is not pressed. >>> Make sure that you have turned on the machine by pressing the On / Off button.

### Dishes are not washed clean

- Dishes are not placed orderly in the machine. >>> Load the dishes as described in the user manual.
- Selected program is unsuitable. >>> Select a program with a higher temperature and cycle time.
- Wash arms are stuck. >>> Prior to starting the program, turn the lower and upper Wash arms by hand to make sure that they rotate freely.
- Wash arms holes are clogged. >>> Lower and upper Wash arms holes might be clogged with small food particles and debris. Clean the Wash arms regularly as illustrated in section "Cleaning and Care".
- Filters are clogged. >>> Check if the filter system is clean. Clean the filter system regularly as illustrated in section "Cleaning and Care".
- Filters are installed incorrectly. >>> Check the filter system and make sure that it is installed correctly.
- Baskets are overloaded. >>> Do not overload the baskets in excess of their capacity.
- Detergent is stored under unsuitable conditions. >>> If you are using powder detergent, do not store the detergent package in humid places. Keep it in a closed container if possible. For ease-of-storing, we recommend you to use tablet detergents.
- Detergent is not sufficient. >>> If you are using powder detergent, adjust the amount of detergent according to the soiling degree of your dishes and/or program definitions. We recommend you to use tablet detergents for optimum results.
- Rinse aid is not sufficient. >>> Check the rinse aid indicator and add rinse aid if necessary. Increase the rinse aid setting if there is enough amount of rinse aid in the machine.
- Detergent dispenser lid is left open. >>> Make sure that the detergent dispenser lid is closed tightly after adding detergent.

### Dishes are not dry at the end of cycle

- Dishes are not placed orderly in the machine. >>> Place your dishes in a way that no water will accumulate in them.
- Rinse aid is not sufficient. >>> Check the rinse aid indicator and add rinse aid if necessary. Increase the rinse aid setting if there is enough amount of rinse aid in the machine.
- Machine is unloaded right after the program is over. >>> Do not unload your machine right after washing process is completed. Slightly open the door and wait for evacuation of the steam inside for a while. Unload the dishes after the pieces cool down to a touchable level. Start unloading process from the lower basket. Thus, dropping of water remained on a piece at upper basket onto the pieces at lower basket is prevented.
- Selected program is unsuitable. >>> Since rinsing temperature is low at program with short duration, drying performance will also be low. Select program with longer duration for a higher drying performance.
- Surface quality of the kitchen utensils is deteriorated. >>> Desired washing performance can not be obtained at kitchen utensils with deteriorated surfaces and it is not suitable to use such utensils in terms of hygiene as well. Also, water can not flow easily on deteriorated surfaces. It is not recommended to wash such kitchen utensils in dishwasher.



It is normal that drying complaints can be experienced with Teflon kitchen utensils. It is associated with the structure of Teflon. Since the surface tensions of Teflon and water are different, water droplets will remain as beads on the Teflon surface.

### Stains remaining on dishes when cycle has completed.

- Selected program is unsuitable. >>> Select a program with a higher temperature and cycle time.
- Surface quality of the kitchen utensils is deteriorated. >>> Tea and coffee stains or other dye spots may not be cleaned in dishwasher when they have penetrated in deteriorated surfaces. Desired washing performance can not be obtained at kitchen utensils with deteriorated surfaces and it is not suitable to use such utensils in terms of hygiene as well. It is not recommended to wash such kitchen utensils in dishwasher.
- Detergent is stored under unsuitable conditions. >>> If you are using powder detergent, do not store the detergent package in humid places. Keep it in a closed container if possible. For ease-of-storing, we recommend you to use tablet detergents.

### Lime traces remain on dishes and glassware gains a misty appearance

- Rinse aid is not sufficient. >>> Check the rinse aid indicator and add rinse aid if necessary. Increase the rinse aid setting if there is enough amount of rinse aid in the machine.

### There is a different odor in the machine



A new machine has a peculiar odor. It will fade out after a couple of washing.

- Filters are clogged. >>> Check if the filter system is clean. Clean the filter system regularly as illustrated in section "Cleaning and Care".
- Dirty dishes are kept in dishwasher for 2-3 days. >>> If you are not going to start the machine right after you have put the dishes into it, remove the remnants on the dishes and run the Prewash program without detergent every 2 days. In such cases, do not close the door of the machine completely in order to avoid odor build up in machine. You can also use commercially available odor removers or machine cleaners.

### **Rust, discoloration or surface deterioration occurs on dishes**

- Salty food remnants have remained on dishes for a long time. >>> If silverware soiled with such foods will be kept waiting in machine, dirt must be removed by prewash or dishes must be washed without being kept waiting.
- Electric installation is not grounded. >>> Check if your machine is connected to the actual grounding line. Otherwise, the static electric created in the product causes arcs on the surfaces of metal items creating pores, removing the protective cover on the surface and causing discoloration.
- Intensive cleansers such as bleaches are used. >>> Protective cover on metal surfaces gets damaged and loses its efficiency in time when it gets in contact with cleansers such as bleach. Do not wash your dishes with bleach.
- Metal items particularly such as knives are used for purposes other than their intended uses. >>> Protective cover on the edges of knives may get damaged when they are used for purposes such as opening cans. Do not use metal kitchen utensils out of their intended uses.
- Silverware are made of low quality stainless steel. >>> Corrosion on such items is inevitable; they should not be washed in dishwashers.
- Kitchen utensils that are already corroded are washed in dishwasher. >>> Rust on a corroded item can migrate to other stainless steel surfaces and cause corrosion on those surfaces as well. Such items should not be washed in dishwashers.

### **Detergent remains in detergent dispenser.**

- Detergent dispenser was damp when adding detergent. >>> Make sure that the detergent dispenser is dried well prior to filling it with detergent.
- Detergent is added long before the washing process. >>> Pay attention to add detergent shortly before start-up of the washing.
- Opening of the detergent dispenser lid is prevented during washing. >>> Place the dishes in a way that will not prevent the detergent dispenser lid from opening and the water going into the machine from impellers.
- Detergent is stored under unsuitable conditions. >>> If you are using powder detergent, do not store the detergent package in humid places. Keep it in a closed container if possible. For ease-of-storing, we recommend you to use tablet detergents.
- Wash Arm holes are clogged. >>> Lower and upper Wash Arm holes might be clogged with food remnants such as lemon pits. Clean the Wash Arm regularly as illustrated in section "Cleaning and Care".

### **Decorations and ornaments on kitchen utensils are being erased.**



Decorated glasses and decorated luster porcelains are not suitable for washing in the dishwasher. Manufacturers of glassware and porcelain tableware items do not recommend washing such kitchen utensils in the dishwasher either.

### **Dishes are scratched.**



Kitchen utensils that contains or are made of aluminum should not be washed in dishwasher.

- Dishes are not placed orderly in the machine. >>> When placing the glasses and other glassware into the basket lean them not against other dishes but the edges or racks of the basket or the glass support wire. Striking of the glasses to each other or to other dishes due to the impact of water during washing can cause breaks, or scratches on their surfaces.

### **A smear remains on glasses that resembles milk stain which can not be removed when wiped by hand. A bluish / rainbow appearance occurs when the glass is pointed to light.**

- Excessive rinse aid is used. >>> Lower rinse aid setting. Clean the spilled rinse aid when adding rinse aid.
- Corrosion has occurred on glass due to soft water. >>> Measure the hardness of the supply water appropriately and check the water hardness setting. Choose programs that wash in higher temperatures (140-149 degrees Fahrenheit). You can also use glass protective detergents that are commercially available.

### **Foam forms in the machine.**

- Dishes are washed with hand-wash detergent by hand but not rinsed before placing them into the machine. >>> Hand-wash detergents do not contain antifoam. There is no need to hand-wash the dishes before placing them into the machine. Removing the coarse soil on the dishes under tap water, with a sponge or towel.
- Rinse aid has spilled into the machine when adding rinse aid. >>> Take care that rinse aid is not spilled in the machine when you are filling it. Clean any spilled rinse aid with the help of a tissue paper/towel.
- Lid of the rinse aid reservoir is left open. >>> Make sure that the lid of the rinse aid reservoir is closed after adding rinse aid.

### **Kitchen utensils are broken.**

- Dishes are not placed orderly in the machine. >>> Load the dishes as described in the user manual.
- Baskets are overloaded. >>> Do not overload the baskets in excess of their capacity.

### **Water remains in the dishwasher at the end of the program.**

- Filters are clogged. >>> Check if the filter system is clean. Clean the filter system regularly as illustrated in section "Cleaning and Care".
- Discharge hose is clogged/blocked. >>> Check the discharge hose. If necessary, remove the discharge hose, clear the blockage and insert it as illustrated in the user manual.



If you cannot eliminate the problem although you follow the instructions in this section, consult your dealer or the Authorized Service Agent. Never try to repair a nonfunctional product yourself.

## 10. TECHNICAL FEATURES

<b>Load capacity</b>	16 place settings
<b>Permissible water pressure</b>	4.35 - 145 psi (0.3 - 10 bars)
<b>Electrical connection</b>	120 V (volts), 12 A (amps), 60Hz (hertz)
<b>Total power</b>	1400 W (watts)
<b>Heater power</b>	1100 W (watts)



**NOTICE:** Because we continually strive to improve our products, we may change our specifications and design without prior notice.  
This device corresponds to the following directives:  
UL 749 Household Dishwasher directive.

If service is required, call your authorized service agency.

Have the following information readily available.

- Model number
- Serial number
- Date purchased
- Name of dealer from whom purchased

Clearly describe the problem that you are having. If you are unable to obtain the name of an authorized service agency, or if you continue to have service problems, contact Viking Range, LLC at 1-888-845-4641, or write to:

VIKING RANGE, LLC  
PREFERRED SERVICE  
111 Front Street  
Greenwood, Mississippi 38930 USA

Record the information indicated below. You will need it if service is ever required. The model and serial numbers are located on an identification label attached to the left side of the tank. For access, simply open the door of the dishwasher.

Model no. \_\_\_\_\_ Serial no. \_\_\_\_\_

Date of purchase \_\_\_\_\_ Date installed \_\_\_\_\_

Dealer's name \_\_\_\_\_

Address \_\_\_\_\_

If service requires installation of parts, use only authorized parts to insure protection under the warranty.

Keep this manual for future reference.

**BUILT-IN DISHWASHERS WARRANTY  
TWO YEAR FULL WARRANTY**

Built-in dishwashers and all of their component parts, except as detailed below\*, are warranted to be free from defective materials or workmanship in normal residential use for a period of two (2) years from the date of original retail purchase. Viking Range, LLC, warrantor, agrees to repair or replace, at its option, any part which fails or is found to be defective during the warranty period.

**\*90 DAY COSMETIC WARRANTY:** Product is warranted to be free from cosmetic defects in materials or workmanship (such as scratches on stainless steel, paint/porcelain blemishes, etc.) for a period of ninety (90) days from the date of original retail purchase or closing date for new construction, whichever period is longer. Any defects must be reported to the selling dealer within ninety (90) days from date of original retail purchase. Viking Range, LLC uses high quality processes and materials available to produce all color finishes. However, slight color variation may be noticed because of the inherent differences in painted parts and porcelain parts as well as differences in kitchen lighting, product locations, and other factors. Therefore, this warranty does not apply to color variation attributable to such factors.

**\*90 Day Residential Plus:** Viking products are designed and certified for residential use only. They are not intended for use in commercial applications. Viking products should only be used in accordance to national and local codes. Viking is not responsible for property damage or injury resulting from use in a commercial application. To support the manufacturing quality of its appliance's Viking will provide a full 90 day warranty for products used in "Residential Plus" applications. This "Residential Plus" warranty applies to applications where use of the product extends beyond residential use but is in compliance with national and local code. In some jurisdictions these applications are zoned as residential. Examples of, but not limited to, such applications covered by this warranty are bed and breakfasts, fire stations, private clubs, churches, condominium/apartment common areas etc. Under this "Residential Plus" warranty, the product, its components and accessories are warranted to be free from defective material or workmanship for a period of ninety (90) days from the date of original retail purchase. Viking Range, LLC, warrantor, agrees to repair or replace, at its option, any part which fails or is found to be defective during the warranty period. This warranty covers parts and labor. This warranty excludes use of the product in all commercial locations such as restaurants, food service locations and institutional food service locations.

**FIVE YEAR LIMITED WARRANTY ON NYLON RACKS, ELECTRONIC CONTROLS, MOTOR/PUMP ASSEMBLY, AND WATER DISTRIBUTION SYSTEM COMPONENTS**

Any upper and/or lower nylon rack which rusts through due to defective materials or workmanship and any electronic controls which fail due to defective materials or workmanship in normal household use during the third through fifth year from the date of original retail purchase will be repaired or replaced, free of charge for the part itself, with the owner paying all other costs, including labor. Any motor/pump assembly or water distribution system component as listed below which fails due to defective materials or workmanship in normal household use during the fourth through fifth year from the date of original retail purchase will be repaired or replaced, free of charge for the part itself, with the owner paying all other costs, including labor.

Motor/Pump and Water Distribution System Components:  
Circulation motor/pump  
Lower wash arm  
Drain motor/pump  
Diverter

Tube to upper wash arm  
Fill valve  
Upper wash arm

**LIFETIME LIMITED WARRANTY ON STAINLESS STEEL TANK AND LINER**

Any stainless steel tank or inner door liner which develops a water leak due to defective materials or workmanship in normal household use during the lifetime of the product will be repaired or replaced, free of charge for the part itself, with the owner paying all other costs, including labor. This warranty excludes surface corrosion or rust, scratches, discoloration, water or atmospheric conditions, or cleaning practices which are part of normal residential use.

**WARRANTY TERMS**

This warranty extends to the original retail purchaser of the product warranted hereunder and to each transferee owner of the product during the term of the original purchaser's warranty. The warranty is transferable by the original retail purchaser via home sale only. If a transferee owner is unable to provide proof of purchase from the original purchaser and the product has not been previously registered, the production date of the product, located in the serial number on the product, will serve as the effective warranty start date. The activation date of the warranty begins from the date of original retail purchase. In the case of new product purchase via building development sales, activation begins from the earlier date of either certificate of occupancy or 24 months from date of manufacture. Note date of manufacture is identified by serial tag on product.

This warranty does not cover units purchased as b-stock, liquidation, salvage, seconds, refurbished, as-is, used products. This warranty shall apply to products purchased in the United States and Canada. Products must be purchased in the country where service is requested. Warranty service must be performed by a Viking Range LLC authorized service agency or representative. Warranty shall not apply to damage resulting from abuse, accident, natural disaster, loss of electrical power to the product for any reason, alteration, improper installation, improper operation, or repair service of the product by anyone other than a Viking Range LLC authorized service agency or representative. This warranty does not apply to commercial usage. Warrantor is not responsible for consequential or incidental damage whether arising out of breach of warranty, breach of contract or otherwise. Some jurisdictions do not allow the exclusion or limitation of incidental or consequential damages, so the above limitations do not apply to you.

Owner shall be responsible for proper installation, providing normal care and maintenance, providing proof of purchase upon request, and making the product reasonably accessible for service. If the product or one of its component parts contains a defect or malfunction during the warranty period, after a reasonable number of attempts by the warrantor to remedy the defects or malfunctions, the owner is entitled to either a refund or replacement, at the warrantor's discretion of the product or its component part or parts. Warrantor's liability on any claim of any kind, with respect to the goods or services covered hereunder, shall in no case exceed the price of the goods or service or part thereof which gives rise to the claim.

**WARRANTY SERVICE**

Under the terms of this warranty, service must be performed by a Viking Range LLC authorized service agent or representative. Service will be provided during normal business hours. Labor performed at overtime or premium rates shall not be covered by the warranty. To obtain warranty service contact Viking Range LLC Customer Care at 1-888-845-4641. Please have model number, serial number, and date of original purchase available when calling. **IMPORTANT:** retain proof of original purchase to establish warranty period. The return of the owner registration card is not a condition of warranty coverage. You should, however, return the owner registration card so Viking Range LLC can contact you should any question of safety arise which could affect you. Any implied warranties of merchantability and fitness applicable to the above described burner assemblies, infrared rotisserie burners, grill grates, and stainless steel parts are limited in duration to the period of coverage of the applicable express written limited warranties set forth above. Some jurisdictions do not allow limitations on how long an implied warranty lasts, so the above limitations may not apply to you. This warranty gives you specific legal rights, and you may also have other rights which may vary from jurisdiction to jurisdiction.

Specifications subject to change without notice



Viking Range, LLC  
111 Front Street  
Greenwood, Mississippi 38930  
(662)455-1200

For more product information call 1-888-845-4641 or  
visit our website at [vikingrange.com](http://vikingrange.com)