



Built-In Electric WALL OVEN

SAFETY INFORMATION3

USING THE OVEN

Single Wall Oven Controls6

Double Wall Oven Controls7

Special Features.....8

Oven Racks10

Aluminum Foil and Oven Liners.....10

Cookware.....10

Cooking Modes.....11

Cooking Guide12

CARE AND CLEANING

Oven.....13

Oven Light.....14

Oven Door.....15

TROUBLESHOOTING TIPS.....16

LIMITED WARRANTY18

ACCESSORIES19

CONSUMER SUPPORT20

OWNER'S MANUAL

- JKS3000 - 27" Single Wall Oven
- JTS3000 - 30" Single Wall Oven
- JKD3000 - 27" Double Wall Oven
- JTD3000 - 30" Double Wall Oven

Write the model and serial numbers here:

Model # _____

Serial # _____

You can find them on a label on the side trim or on the front of the (lower) oven behind the oven door.

ESPAÑOL

Para consultar una version en español de este manual de instrucciones, visite nuestro sitio de internet GEAppliances.com.

THANK YOU FOR MAKING GE APPLIANCES A PART OF YOUR HOME.

Whether you grew up with GE Appliances, or this is your first, we're happy to have you in the family.

We take pride in the craftsmanship, innovation and design that goes into every GE Appliances product, and we think you will too. Among other things, registration of your appliance ensures that we can deliver important product information and warranty details when you need them.

Register your GE appliance now online. Helpful websites and phone numbers are available in the Consumer Support section of this Owner's Manual. You may also mail in the pre-printed registration card included in the packing material.



IMPORTANT SAFETY INFORMATION

READ ALL INSTRUCTIONS BEFORE USING THE APPLIANCE

▲WARNING Read all safety instructions before using the product. Failure to follow these instructions may result in fire, electrical shock, serious injury or death.

▲WARNING GENERAL SAFETY INSTRUCTIONS

- Use this appliance only for its intended purpose as described in this Owner's Manual.
- Be sure your appliance is properly installed and grounded by a qualified installer in accordance with the provided installation instructions.
- Do not attempt to repair or replace any part of your oven unless it is specifically recommended in this manual. All other servicing should be performed by a qualified technician.
- Before performing any service, disconnect the power supply at the household distribution panel by removing the fuse or switching off the circuit breaker.
- Do not leave children alone—children should not be left alone or unattended in an area where an appliance is in use. They should never be allowed to climb, sit or stand on any part of the appliance.
- **▲CAUTION** Do not store items of interest to children in cabinets above an oven - children climbing on the oven to reach items could be seriously injured.
- Use only dry pot holders—moist or damp pot holders on hot surfaces may result in burns from steam. Do not let pot holders touch hot heating elements. Do not use a towel or other bulky cloth in place of pot holders.
- Never use your appliance for warming or heating the room.
- Do not touch the heating elements or the interior surface of the oven. These surfaces may be hot enough to burn even though they are dark in color. During and after use, do not touch, or let clothing or other flammable materials contact any interior area of the oven; allow sufficient time for cooling first. Other surfaces of the appliance may become hot enough to cause burns. Potentially hot surfaces include the oven vent opening, surfaces near the opening and crevices around the oven door.
- Do not heat unopened food containers. Pressure could build up and the container could burst, causing an injury.
- Do not use any type of foil or liner to cover the oven bottom or anywhere in the oven, except as described in this manual. Oven liners can trap heat or melt, resulting in damage to the product and risk of shock, smoke or fire.
- Avoid scratching or impacting glass doors or control panels. Doing so may lead to glass breakage. Do not cook on a product with broken glass. Shock, fire or cuts may occur.
- Cook meat and poultry thoroughly—meat to at least an internal temperature of 160°F and poultry to at least an internal temperature of 180°F. Cooking to these temperatures usually protects against foodborne illness.

▲WARNING KEEP FLAMMABLE MATERIALS AWAY FROM THE OVEN

Failure to do so may result in fire or personal injury.

- Do not store or use flammable materials in or near an oven, including paper, plastic, pot holders, linens, wall coverings, curtains, drapes and gasoline or other flammable vapors and liquids.
- Never wear loose-fitting or hanging garments while using the appliance. These garments may ignite if they contact hot surfaces, causing severe burns.
- Do not let cooking grease or other flammable materials accumulate in or near the oven. Grease in the oven or near the oven may ignite.
- **Remote Operation** - This appliance is configurable to allow remote operation at any time. Do not store any flammable materials or temperature sensitive items inside of the appliance.

READ AND SAVE THESE INSTRUCTIONS

IMPORTANT SAFETY INFORMATION

READ ALL INSTRUCTIONS BEFORE USING THE APPLIANCE

▲WARNING IN THE EVENT OF A FIRE, TAKE THE FOLLOWING STEPS TO PREVENT INJURY AND FIRE SPREADING

- Do not use water on grease fires. Never pick up a flaming pan.
- If there is a fire in the oven during baking, smother the fire by closing the oven door and turning the oven off or by using a multi-purpose dry chemical or foam-type fire extinguisher.
- If there is a fire in the oven during self-clean, turn the oven off and wait for the fire to go out. Do not force the door open. Introduction of fresh air at self-clean temperatures may lead to a burst of flame from the oven. Failure to follow this instruction may result in severe burns.

▲WARNING OVEN SAFETY INSTRUCTIONS

- Stand away from the oven when opening the oven door. Hot air or steam which escapes can cause burns to hands, face and/or eyes.
- Keep the oven vent unobstructed.
- Keep the oven free from grease buildup. Grease in the oven may ignite.
- Place oven racks in desired location while oven is cool. If rack must be moved while oven is hot, do not let pot holder contact hot heating element in oven.
- When using cooking or roasting bags in the oven, follow the manufacturer's directions.
- Pulling out the standard racks to their stop-locks or the extension rack to its fully open position is a convenience in lifting heavy foods. It is also a precaution against burns from touching hot surfaces of the door or oven walls.
- Do not leave items such as paper, cooking utensils or food in the oven when not in use. Items stored in an oven can ignite.
- Never place cooking utensils, pizza or baking stones, or any type of foil or liner on the oven floor. These items can trap heat or melt, resulting in damage to the product and risk of shock, smoke or fire.

▲WARNING SELF-CLEANING OVEN SAFETY INSTRUCTIONS

The self-cleaning feature operates the oven at temperatures high enough to burn away food soils in the oven. Follow these instructions for safe operation.

- Do not touch oven surfaces during self-clean operation. Keep children away from the oven during self-cleaning. Failure to follow these instructions may cause burns.
- Before self-cleaning the oven, remove shiny silver colored oven racks (on some models), the probe, any aluminum foil, and any broiler pan, grid, and other cookware. Only porcelain coated oven racks may be left in the oven.
- Before operating the self-clean cycle, wipe grease and food soils from the oven. Excessive amount of grease may ignite, leading to smoke damage to your home.

READ AND SAVE THESE INSTRUCTIONS

IMPORTANT SAFETY INFORMATION

READ ALL INSTRUCTIONS BEFORE USING THE APPLIANCE

▲WARNING SELF-CLEANING OVEN SAFETY INSTRUCTIONS (Cont.)

- If the self-cleaning mode malfunctions, turn the oven off and disconnect the power supply. Have it serviced by a qualified technician.
- Do not clean the door gasket. The door gasket is essential for a good seal. Care should be taken not to rub, damage or move the gasket.
- Do not use oven cleaners. No commercial oven cleaner or oven liner protective coating of any kind should be used in or around any part of the oven.

The remote enable equipment installed on this oven has been tested and found to comply with the limits for a Class B digital device, pursuant to part 15 of the FCC Rules. These limits are designed to:

(a) provide reasonable protection against harmful interference in a residential installation. This equipment generates, uses and can radiate radio frequency energy and, if not installed and used in accordance with the instructions, may cause harmful interference to radio communications. However, there is no guarantee that interference will not occur in a particular installation. If this equipment does cause harmful interference to radio or television reception, which can be determined by turning the equipment off and on, the user is encouraged to try to correct the interference by one or more of the following measures:

- Reorient or relocate the receiving antenna.
 - Increase the separation between the equipment and receiver.
 - Connect the equipment into an outlet on a circuit different from that to which the receiver is connected.
 - Consult the dealer or an experienced radio/TV technician for help.
- (b) accept any interference received, including interference that may cause undesired operation of the device.

Note that any changes or modifications to the wireless communication device installed on this oven that are not expressly approved by the manufacturer could void the user's authority to operate the equipment.

How to Remove Protective Shipping Film and Packaging Tape

Carefully grasp a corner of the protective shipping film with your fingers and slowly peel it from the appliance surface. Do not use any sharp items to remove the film. Remove all of the film before using the appliance for the first time.

To assure no damage is done to the finish of the product, the safest way to remove the adhesive from packaging tape on new appliances is an application of a household liquid dishwashing detergent. Apply with a soft cloth and allow to soak.



NOTE: The adhesive must be removed from all parts. It cannot be removed if it is baked on.

READ AND SAVE THESE INSTRUCTIONS

Single Wall Oven Controls

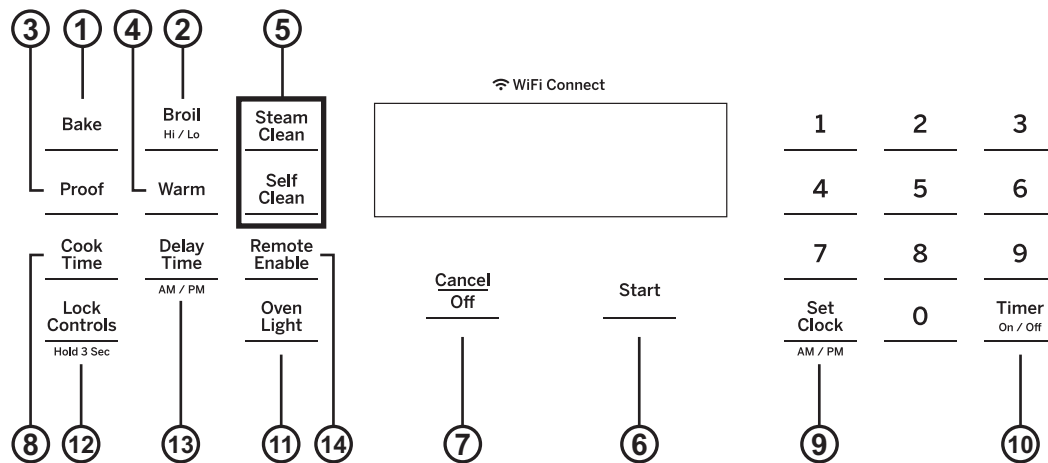
Control button shapes are representative; your oven may have alternate button shapes.



- Bake:** Touch this pad to select the bake function. See the Cooking Modes section for more information.
- Broil:** Touch this pad to select the broil function. See the Cooking Modes section for more information.
- Proof:** Helps yeast bread rise. See the Cooking Modes section for more information.
- Warm:** Keeps hot food warm. See the Cooking Modes section for more information.
- Clean:** Your oven has two cleaning modes: Self Clean and Steam Clean. See the Cleaning the Oven section for important information about using these modes.
- Start:** Must be pressed to start any cooking, cleaning, or timed function.
- Cancel/Off:** Cancels ALL oven operations except the clock and timer.
- Cook Time:** Counts down cooking time and turns off the oven when the cooking time is complete. Initiate either a bake or warm mode, but don't press **Start**. Press the **Cook Time** pad, use the number pads to program a cooking time in hours and minutes, then press **Start**.
- Set Clock:** Sets the oven clock time. Press the **Set Clock** pad and the number pads to program the clock. Press **Set Clock** to toggle between AM and PM. Press **Start** to save the time.
- Timer:** Works as a countdown timer. Press the **Timer** pad and the number pads to program the time in hours and minutes. Press the **Start** pad. The control will beep with 1 minute remaining and the display will show seconds until the timer counts down to :00. The oven will continue to operate when the timer countdown is complete. To turn the timer off press the **Timer** pad.
- Oven Light(s):** Turns the oven light(s) on or off. Note that opening a door only turns on the light in that oven.
- Lock Controls:** Locks out the control so that pressing the pads does not activate the controls. Press and hold the **Lock Controls** pad for three seconds to lock or unlock the control. Locking the controls will cancel active functions other than the timer.
- Delay Time:** Delays when the oven will turn on. Use this to set a time when you want the oven to start. Initiate either a bake or self clean mode, but don't press **Start**. Press the **Delay Time** pad and use the number pads to program the time of day for the oven to turn on, use **Delay Time** to toggle between AM and PM, then press **Start**. With bake, a cook time may also be programmed if desired. Follow the directions under Cook Time for setting this feature. This can only be used with Bake and Self-Clean.
NOTE: When using the delay time feature, foods that spoil easily—such as milk, eggs, fish, stuffings, poultry and pork—should not be allowed to sit for more than 1 hour before or after cooking. Room temperature promotes the growth of harmful bacteria. Be sure that the oven light is off because heat from the bulb will speed harmful bacteria growth.
- Remote Enable:**
CONNECTING YOUR OVEN 
Off - Oven is not connected. Open the app then press and hold **Remote Enable** pad for 5 seconds to begin the connecting process.
Slow flash - Oven is in discovery mode and looking for a network.
Rapid flash - An error occurred during the connecting process.
Solid - Oven is connected to the network and can be remotely controlled by a connected mobile device when in operation, but it cannot be started remotely.
REMOTE STARTING YOUR OVEN  **REMOTE**
To be able to start the oven remotely, press the **Remote Enable** pad and the **REMOTE** icon will turn on in the display. The oven can now be remotely started with a connected device. The **REMOTE** icon must be lit to start the oven remotely. The **REMOTE** icon is not required to change the oven settings or to turn the oven off. After using the oven, remember to verify that the **REMOTE** icon is lit if you wish to start the oven remotely in the future. To disconnect your phone from Remote Enable, press the Remote Enable pad and the Remote icon will turn off.

Double Wall Oven Controls

Control button shapes are representative; your oven may have alternate button shapes.

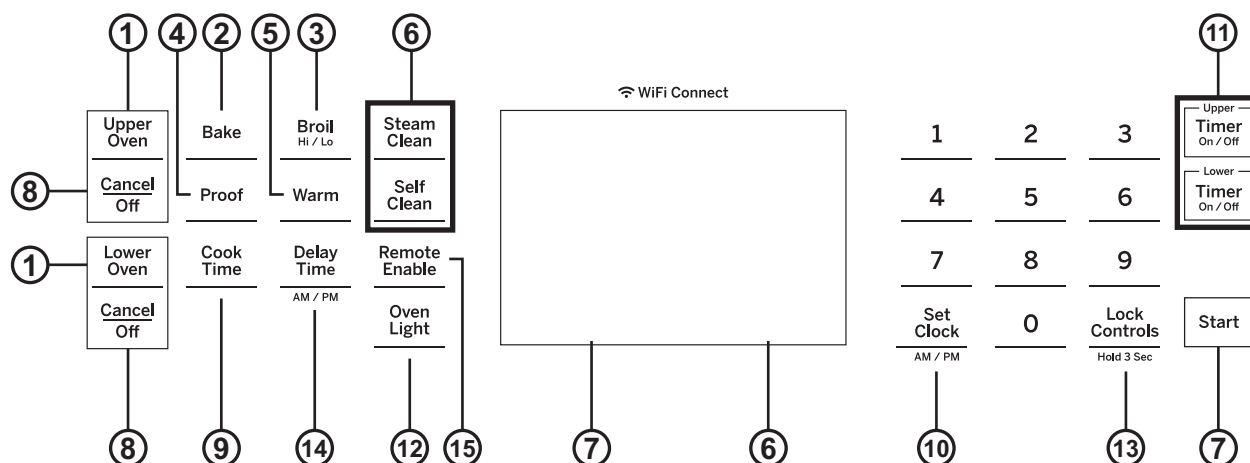

1. **Upper Oven and Lower Oven:** Designates which oven the controls will operate.
2. **Bake:** Touch this pad to select the bake function. See the Cooking Modes section for more information.
3. **Broil:** Touch this pad to select the broil function. See the Cooking Modes section for more information.
4. **Proof:** Helps yeast bread rise. See the Cooking Modes section for more information. Note that proof cannot be run when running a clean mode in the lower oven.
5. **Warm:** Keeps hot food warm. See the Cooking Modes section for more information.
6. **Clean:** Your oven has two cleaning modes: **Self Clean** and **Steam Clean**. See the Cleaning the Oven section for important information about using these modes. Note that proof cannot be run when running a clean mode in the lower oven.
7. **Start:** Must be pressed to start any cooking, cleaning, or timed function.
8. **Cancel/Off:** Cancels ALL oven operations except the clock and timer.
9. **Cook Time:** Counts down cooking time and turns off the oven when the cooking time is complete. Initiate either a bake or warm mode, but don't press **Start**. Press the **Cook Time** pad, use the number pads to program a cooking time in hours and minutes, then press **Start**.
10. **Set Clock:** Sets the oven clock time. Press the **Set Clock** pad and the number pads to program the clock. Press **Set Clock** to toggle between AM and PM. Press **Start** to save the time.
11. **Timer:** Works as a countdown timer. Press the **Timer** pad and the number pads to program the time in hours and minutes. Press the **Start** pad. The control will beep with 1 minute remaining and the display will show seconds until the timer counts down to :00. The oven will continue to operate when the timer countdown is complete. To turn the timer off press the **Timer** pad.
12. **Oven Light(s):** Turns the oven light(s) on or off in both ovens. Note that opening a door only turns on the light in that oven.

13. **Lock Controls:** Locks out the control so that pressing the pads does not activate the controls. Press and hold the **Lock Controls** pad for three seconds to lock or unlock the control. Locking the controls will cancel active functions other than the timer.
14. **Delay Time:** Delays when the oven will turn on. Use this to set a time when you want the oven to start. Initiate either a bake or self clean mode, but don't press **Start**. Press the **Delay Time** pad and use the number pads to program the time of day for the oven to turn on, use **Delay Time** to toggle between AM and PM, then press **Start**. With bake, a cook time may also be programmed if desired. Follow the directions under Cook Time for setting this feature. This can only be used with Bake and Self-Clean.
NOTE: When using the delay time feature, foods that spoil easily—such as milk, eggs, fish, stuffings, poultry and pork—should not be allowed to sit for more than 1 hour before or after cooking. Room temperature promotes the growth of harmful bacteria. Be sure that the oven light is off because heat from the bulb will speed harmful bacteria growth.
15. **Remote Enable:**

CONNECTING YOUR OVEN

Off - Oven is not connected. Open the app then press and hold **Remote Enable** pad for 5 seconds to begin the connecting process.

Slow flash - Oven is in discovery mode and looking for a network.

Rapid flash - An error occurred during the connecting process.

Solid - Oven is connected to the network and can be remotely controlled by a connected mobile device when in operation, but it cannot be started remotely.

REMOTE STARTING YOUR OVEN REMOTE

To be able to start the oven remotely, press the **Remote Enable** pad and the **REMOTE** icon will turn on in the display. The oven can now be remotely started with a connected device. The **REMOTE** icon must be lit to start the oven remotely. The **REMOTE** icon is not required to change the oven settings or to turn the oven off. To disconnect your phone from Remote Enable, press the **Remote Enable** pad and the **REMOTE** icon will turn off. After using the oven, remember to verify that the **REMOTE** icon is lit if you wish to start the oven remotely in the future.

Special Features

There are several different special features on your wall oven. To change the settings of these special features, press the **Bake** and **Broil** pads at the same time and hold for three seconds. "OFFSETE" ("OFFSETEP" on double ovens) will appear in the display. For each of the features below, select and edit the feature you want to change by using the **8** and **2** pads to scroll up and down, the **6** pad to edit (or **Save** and exit), and the **4** pad to return to the prior menu without saving.

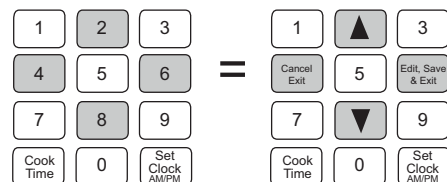

Adjust the Oven Temperature (OFFSETE)

This feature allows the oven baking temperature to be adjusted up to 35°F hotter or down to 35°F cooler. Use this feature if you believe your oven temperature is too hot or too cold and wish to change it. **For double oven models, the upper and lower ovens are adjusted separately.** Do not use thermometers, such as those found in grocery stores, to check the temperature setting of your oven. These thermometers may vary 20–40 degrees. Navigate to "OFFSETE" for single ovens, "OFFSETEP" for the upper oven or "OFFSETELO" for the lower oven. Press **6** to edit the offset. "0" or a number between + and - 35 will be displayed. Press **2** to increase, **8** to decrease. -35 to +35 is the available offset range. Press **6** to save and exit. Press **4** to exit without saving.

Sound Volume (SOUND)

This feature allows the oven tone volume to be adjusted. Navigate to "SOUND" and press **6** to view or change the current setting. Scrolling through allows you to hear each volume level.

End of Timer Signals (ENDTONE)

This is the tone that signals the end of a timer. The tone can be continuous "CONTBEEP" or one repeating beep "BEEP". A continuous setting will continue to sound a tone until a button on the control is pressed. Navigate to "ENDTONE" and press **6** to view or change the current setting.

Fahrenheit or Celsius Temperature Display (UNITDEG)

The oven control is set to use Fahrenheit temperatures (F), but you can change it to use Celsius temperatures (C). Navigate to "UNITDEG" and press **6** to view or change the current setting.

Clock Display (CLOCKDISP)

This feature turns the clock on or off in the display. Navigate to "CLOCKDISP" and press **6** to view or change the current setting.

Clock Configuration (CLOCKCFG)

This feature specifies how the time of day will be displayed or if no time of day will be displayed. You can select a standard 12-hour clock (12H) or 24-hour military time display (24H). Navigate to "CLOCKCFG" and press **6** to view or change the current setting.

12-Hour Shutoff (12HR)

When this feature is turned on, the oven will automatically turn off after 12 continuous hours of use. Navigate to "12HR" and press **6** to view or change the current setting.

Special Features (Cont.)

Sabbath

Sabbath mode disables the oven lights (the oven light will not turn on when the door is opened), all sounds (the control will not beep when a button is pressed), Broil, Warm, Proof, Cook Time, Timer, Clock, and Delay Time functions. Sabbath mode can only be used with Bake. This feature conforms to the Star-K Jewish Sabbath requirements.

Press and hold the **Bake** and **Broil** pads for 3 seconds to enter special features.

Press the **8** and **2** pads to scroll up and down until "SABBAH" appears in the display. Use the **6** pad to view and edit the current setting, **2** and **8** to change the setting, and **6** again to **Save**, **4** to exit the Special Features and Start Sabbath mode. (Alternately, use the **4** pad to return to the prior menu from the Sabbath menu without saving). A] will appear in the display and the clock will not display.

Note that if you have a double wall oven, when you place the control into Sabbath mode, both ovens are now in Sabbath mode and available for cooking.

Once in Sabbath mode, at any time you can press **Bake**, use the number pads to enter a temperature between 170F and 550F, and press **Start**. No sound will be given when the keys are pressed. At a random time between 30 seconds and 1 minute,]], will appear in the display indicating the oven is running.

Note that both ovens of a double wall oven can be used in Sabbath mode. Each oven can be programmed to a different temperature and each oven must be programmed separately by selecting the oven before starting the bake mode.

If you need to adjust the temperature, press **Bake**, use the number pads to enter a new temperature between 170F and 550F, and press **Start**.

To turn the oven off, press **Cancel/Off** at any time. **The oven will immediately turn off** and] will change to] indicating that the oven has turned off.

Note that each oven of a double wall oven must be turned off separately.

To exit Sabbath mode, make sure that the oven is turned off. Press and hold the **Bake** and **Broil** pads for 3 seconds to enter special features then press **2** or **8** to scroll to "SABBAH", **6** to edit, **2** or **8** to change setting to **Off**, **6** to save settings, **4** to exit from Special Features menus. The clock will return to the display when Sabbath mode is off.

NOTE: If power outage occurs during Sabbath mode the unit will remain in Sabbath mode but off when power is restored.

If you wish to use the Cook Time feature to bake in the oven and then have the oven automatically turn off, you will need to press the **Cook Time** button, enter a cooking time duration, and press **Start**. Then enter special features to start Sabbath mode as detailed above.

Oven Racks

Your oven has six rack positions. Recommended rack positions for various types of foods are provided in the Cooking Guide. Adjusting rack position is one way to impact cooking results. For example, if you would prefer darker tops on cakes, muffins, or cookies, try moving food one rack position higher. If you find foods are too brown on top try moving them down next time.

When baking with multiple pans and on multiple racks, ensure there is at least 1½" between pans to allow sufficient space for air to flow.

To avoid possible burns, place the racks in the desired position before you turn the oven on.

Traditional Flat Racks

When placing and removing cookware, pull the rack out to the bump (stop position) on the rack support.

To remove a rack, pull it toward you, tilt the front end up and pull it out.

To replace, place the curved end of the rack (stop-locks) onto the oven supports, tilt up the front of the rack and push the rack in.

Racks may become difficult to slide, especially after a self-clean. Put some vegetable oil on a soft cloth or paper towel and rub onto the left and right edges of the racks.

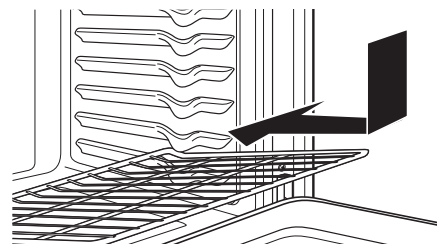
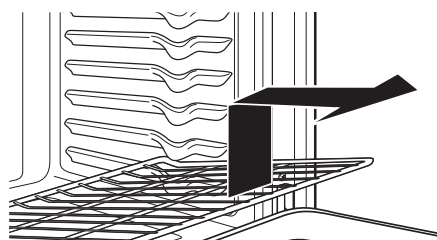
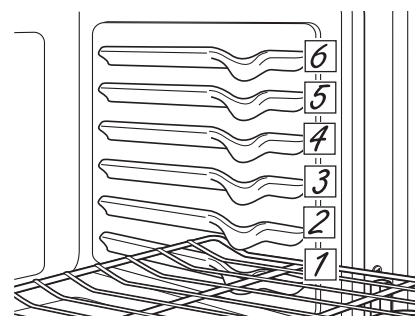

Aluminum Foil and Oven Liners

▲ CAUTION Do not use any type of foil or oven liner to cover the oven bottom. These items can trap heat or melt, resulting in damage to the product and risk of shock, smoke or fire. Damage from improper use of these items is not covered by the product warranty.

Foil may be used to catch spills by placing a sheet on a lower rack, several inches below the food. Do not use more foil than necessary and never entirely cover an oven rack with aluminum foil. Keep foil at least 1-1/2" from oven walls to prevent poor heat circulation.

Cookware

Cookware Guidelines

The material, finish, and size of cookware affect baking performance.

Dark, coated and dull pans absorb heat more readily than light, shiny pans. Pans that absorb heat more readily can result in a browner, crisper, and thicker crust. If using dark and coated cookware check food earlier than minimum cook time. If undesirable results are obtained with this type of cookware consider reducing oven temperature by 25° F next time.

Shiny pans can produce more evenly cooked baked goods such as cakes and cookies.

Glass and ceramic pans heat slowly but retain heat well. These types of pans work well for dishes such as pies and custards.

Air insulated pans heat slowly and can reduce bottom browning.

Keep cookware clean to promote even heating.

Cooking Modes

Your new oven has a variety of cooking modes to help you get the best results. These modes are described below. Refer to the Cooking Guide section for recommendations for specific foods. Remember, your new oven may perform differently than the oven it is replacing.

Bake

The bake mode is for baking and roasting. This mode uses heat primarily from the lower element but also from the upper element to cook food. When preparing baked goods such as cakes, cookies, and pastries always preheat the oven first. Follow recipe recommendations for food placement. If no guidelines are provided center food in the oven. To use this mode press the **Bake** pad, enter a temperature, and then press **Start**.

Proof

Proof mode is designed for rising (fermenting and proofing) bread doughs. Press the **Proof** pad and then press **Start**. Cover dough well to prevent drying out. Bread will rise more rapidly than at room temperature. Note that for double wall ovens, proof can not be run when running a clean mode in the other oven.

Warm

Warm mode is designed to keep hot foods hot for up to 3 hours. To use this mode, press the **Warm** pad then press **Start**. Cover foods that need to remain moist and do not cover foods that should be crisp. Preheating is not required. Do not use warm to heat cold food other than crisping crackers, chips or dry cereal. It is also recommended that food not be kept warm for more than 2 hours.

Broiling Modes

Always broil with the door closed. The broil element in this oven is very powerful. Monitor food closely while broiling. Use caution when broiling on upper rack positions as placing food closer to the broil element increases smoking, spattering, and the possibility of fats igniting. For best performance center food below the broil heating element. **Broiling on rack position 6 is not recommended.**

Try broiling foods that you would normally grill. Adjust rack positions to adjust the intensity of the heat to the food. Place foods closer to the broil element when a seared surface and rare interior is desired. Thicker foods and foods that need to be cooked through should be broiled on a rack position farther from the broiler or by using Broil Lo.

Broil Hi

The Broil Hi mode uses intense heat from the upper element to sear foods. Use Broil Hi for thinner cuts of meat and/or foods you prefer less done on the interior. To use this mode press the **Broil** pad once and then press **Start**. It is not necessary to preheat when using this mode.

Broil Lo

The Broil Lo mode uses less intense heat from the upper element to cook food thoroughly while also producing surface browning. Use Broil Lo for thicker cuts of meat and/or foods that you would like cooked all the way through. To use this mode press the **Broil** pad **twice** and then press **Start**. It is not necessary to preheat when using this mode.

Cooking Guide

FOOD TYPE	RECOMMENDED MODE(S)	RECOMMENDED RACK POSITION(S)	ADDITIONAL SUGGESTIONS
Baked Goods			
Layer cakes, sheet cakes, bundt cakes, muffins, quick breads on a Single Rack	Bake	3	Use shiny cookware.
Layer cakes* on Multiple Racks	Bake	2 and 4	Ensure adequate airflow (see illustration below).
Chiffon cakes (angel food)	Bake	1	Use shiny cookware.
Cookies, biscuits, scones on a Single Rack	Bake	3	Use shiny cookware.
Cookies, biscuits, scones on Multiple Racks	Bake	2 and 4	For foods like sugar cookies, switch food location partially through cooking for more even cooking results between racks. Ensure adequate airflow.
Beef & Pork			
Hamburgers	Broil Hi	5	Use a broil pan; move food down for more doneness/less searing. Watch food closely when broiling. For best performance center food below the broil heating element.
Steaks & Chops	Broil Hi	5	Use a broil pan; move food down for more doneness/less searing. Watch food closely when broiling. For best performance center food below the broil heating element.
Roasts	Bake	2	Leave uncovered, use a low sided pan such as a broil pan. Preheating is not necessary.
Poultry			
Whole chicken	Bake	2	Use a low sided pan such as a broil pan. Preheating is not necessary.
Bone-in chicken breasts, legs, thighs	Broil Lo Bake	3	Broil skin side down first. Watch food closely when broiling. For best performance when broiling, center food below the broil heating element.
Boneless chicken breasts	Broil Lo Bake	3	Move food down for more doneness/less searing and up for greater searing/browning when broiling. For best performance when broiling, center food below the broil heating element.
Whole turkey	Bake	1 or 2	Use a low sided pan such as a broil pan. Preheating is not necessary.
Turkey Breast	Bake	2	Use a low sided pan such as a broil pan. Preheating is not necessary.
Fish	Broil Lo	5 (1/2 thick or less) 4 (>1/2 inch)	Watch food closely when broiling. For best performance center food below the broil heating element.
Casseroles	Bake	3	
Frozen Convenience Foods			
Potato products, chicken nuggets, appetizers on a Single Rack	Bake	3	Use shiny cookware.
Potato products, chicken nuggets, appetizers on Multiple Racks	Bake	2 and 4	Use shiny cookware. Switch food location partially through cooking for more even cooking results.

*When baking four cake layers at a time, use racks 2 and 4. Place the pans as shown so that one pan is not directly above another.

Cook food thoroughly to help protect against food borne illness. Minimum safe food temperature recommendations for food safety can be found at IsItDoneYet.gov. Make sure to use a food thermometer to take food temperatures.

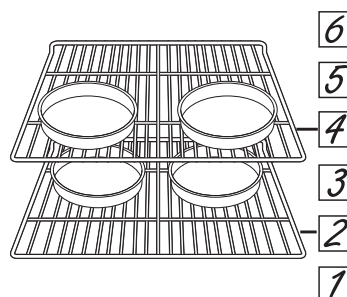

Oven

Be sure electrical power is off and all surfaces are cool before cleaning any part of the oven.

Control Panel

It's a good idea to wipe the control panel after each use. Clean with mild soap and water or vinegar and water, rinse with clean water and polish dry with a soft cloth.

Do not use abrasive cleansers, strong liquid cleansers, plastic scouring pads or oven cleaners on the control panel—they will damage the finish.

Oven Exterior

Do not use oven cleaners, abrasive cleansers, strong liquid cleansers, steel wool, plastic scouring pads, or cleaning powders on the interior or exterior of the oven. Clean with a mild soap and water or vinegar and water solution. Rinse with clean water and dry with a soft cloth. When cleaning surfaces, make sure that they are at room temperature and not in direct sunlight.

If stain on the door vent trim is persistent, use a mild abrasive cleaner and a sponge-scrubber for best results.

Spillage of marinades, fruit juices, tomato sauces and basting liquids containing acids may cause discoloration and should be wiped up immediately. Let hot surfaces cool, then clean and rinse.

Stainless Steel Surfaces (on some models)

Do not use a steel wool pad; it will scratch the surface.

To clean the stainless steel surface, use warm sudsy water or a stainless steel cleaner or polish. Always wipe the surface in the direction of the grain. Follow the cleaner instructions for cleaning the stainless steel surface.

Cleaners with oxalic acid such as Bar Keepers Friend Soft Cleanser™ will remove surface rust, tarnish and small

blemishes. Use only a liquid cleanser free of grit and rub in the direction of the brush lines with a damp, soft sponge.

To inquire about purchasing cleaning products including stainless steel appliance cleaner or polish read the Accessories sections of this manual.

Oven Interior

The interior of your new oven can be cleaned manually or by using the Steam Clean or Self Clean modes.

Spillage of marinades, fruit juices, tomato sauces and basting liquids containing acids may cause discoloration and should be wiped up immediately. Let hot surfaces cool, then clean and rinse.

Manual Cleaning

Do not use oven cleaners, abrasive cleaners, strong liquid cleansers, steel wool, scouring pads, or cleaning powders on the interior of the oven. Clean with a mild soap and water or vinegar and water solution. Rinse with clean water and dry with a soft cloth. When cleaning surfaces, make sure that they are at room temperature.

Steam Clean Mode

Steam clean is intended to clean small spills using water and a lower cleaning temperature than Self-Clean.

To use the Steam Clean feature, wipe grease and soils from the oven. Pour one cup of water into the bottom of the oven. Close the door. Press the **Steam Clean** pad and then press **Start**. The oven door will lock. You can not open the door during the 30 minute steam clean as this will decrease the steam clean performance. At the end of the steam clean cycle the door will unlock. Wipe out any excess water and any remaining soil.

NOTE: Water in the bottom of the oven may be hot right after finishing the cycle.

Self Clean Mode

Read Self-Cleaning Oven Safety Instructions at the beginning of this manual before using Self Clean Mode. Self clean uses very high temperatures to clean the oven interior. The oven door will lock when using this feature. Before operating the self-clean cycle, wipe up grease and soils from the oven. Remove all items from the oven other than enameled (dark color) racks. Shiny or silver racks and any cookware or other items should all be removed from the oven before initiating a self-clean cycle. Close the door. Press the **Self Clean** pad and a default self-clean time is displayed. The clean time can be changed to any time between 3:00 and 5:00 hours by using the number pads to enter a different time and pressing **Start**. For heavily soiled ovens, the maximum 5 hour clean time is recommended. If you wish to use the default time, press the **Start** pad immediately after pressing the **Self Clean** pad. The oven will turn off automatically when the self-clean cycle is complete. The door will stay locked until the oven has cooled down. After the oven has cooled down wipe any ash out of the oven.

IMPORTANT: The health of some birds is extremely sensitive to the fumes given off during the self-cleaning cycle of any range. Move birds to another well-ventilated room.

Oven (Cont.)

Flat Racks

Flat racks that are enameled, not shiny, can be left in the cavity during self clean, or can be washed with warm, soapy water.

Racks may be more difficult to slide, especially after a self-clean. Put some vegetable oil on a soft cloth or paper towel and rub onto the left and right edges.

Oven Light

⚠ WARNING SHOCK OR BURN HAZARD: Before replacing oven light bulb, disconnect the electrical power to the oven at the main fuse or circuit breaker panel. Failure to do so may result in electric shock or burn.

⚠ CAUTION BURN HAZARD: The glass cover and bulb should be removed when cool. Touching hot glass with bare hands or a damp cloth can cause burns.

1. Disconnect power at the main fuse or circuit breaker panel.
2. Remove oven racks.
3. Slide a flat blade screwdriver or butter knife between the metal housing and the glass light cover.
NOTE: on some models there is a metal clip visibly holding the glass. The tool needs inserted between the metal housing and the clip holding the glass.
4. Support the glass light cover with two fingers to prevent the cover from falling to the bottom of the oven.
5. Gently twist the screwdriver blade or butter knife to loosen the glass light cover. Be careful not to chip the oven coating.
6. Remove the glass light cover.
7. Remove the bulb by firmly grasping and sliding the bulb straight out until the two prongs have cleared the ceramic holder.
8. Do not touch the glass of the new replacement bulb with your fingers. It will cause the bulb to fail when it lights. Grasp the replacement bulb with a clean towel or facial tissue with the prongs facing down. Align the two prongs in the ceramic holder, pressing gently until the bulb is securely in the ceramic socket.
9. Slide the protective lens into the holder and push until the clips snap into the housing.
10. Reconnect power.

Oven Door

Oven Door Removal

NOTE: Door removal is not a requirement for installation of the product but is an added convenience.

To remove the door:

1. Open the oven door as far as it will go.
2. Remove hinge bracket (if present) from front frame and set aside. The hinge bracket must be replaced for proper door functionality when door is reinstalled.
3. Push both hinge locks down toward the door frame to the unlocked position. This may require a flat-blade screwdriver. **DO NOT LIFT THE DOOR BY THE HANDLE!**
4. Place hands on both sides of the door and close the oven door to the removal position (approximately 1"–2" [2.5 cm–5.1 cm] from the closed position).
5. Lift the door up and out until the hinge arms clear the slots. **NOTE:** The oven door is very heavy. Be sure you have a firm grip before lifting the oven door off the hinges. Use caution once the door is removed. Do not lay the door on its handle. This could cause dents or scratches.

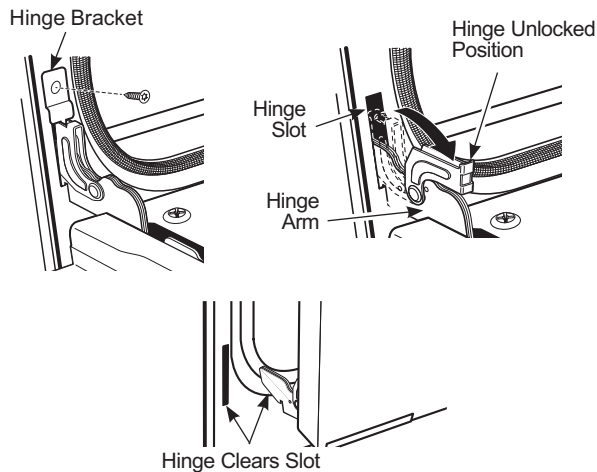

Replacing the Oven Door

NOTE: The oven door is heavy. You may need help lifting the door high enough to slide it into the hinge slots. Do not lift the door by the handle.

1. Lift the oven door by grasping each side.
2. With the door at the same angle as the removal position (approximately 1"–2" [2.5 cm–5.1 cm] from the closed position), seat the notch of the hinge arm into the bottom edge of the hinge slot. The notch of the hinge arm must be fully seated into the bottom of the slot.
3. Fully open the door. If the door will not fully open, the indentation is not seated correctly in the bottom edge of the slot.
4. Push the hinge locks up against the front frame of the oven cavity, to the locked position.
5. Replace hinge bracket (if present). The hinge bracket must be replaced for proper door functionality.
6. Close the oven door.

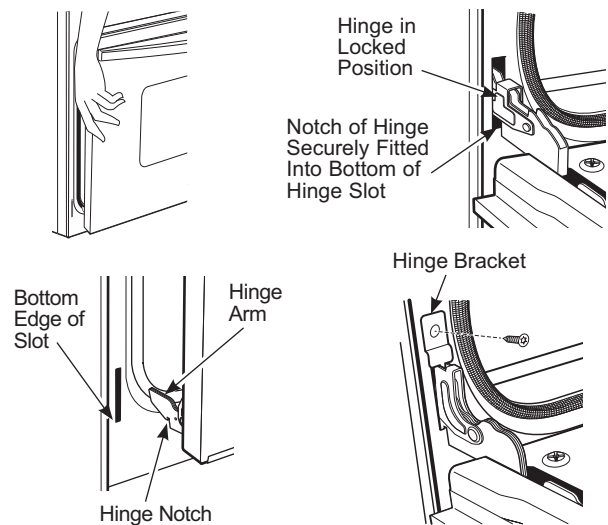



Troubleshooting tips ... Before you call for service

Save time and money! Review the charts on the following pages or visit GEAppliances.com/ge/service-and-support/cookingproducts.htm for helpful articles and support videos before you call for service.

Problem	Possible Cause	What To Do
My new oven doesn't cook like my old one. Is something wrong with the temperature settings?	Your new oven has a different cooking system from your old oven and therefore may cook differently than your old oven.	For the first few uses, follow your recipe times and temperatures carefully. If you still think your new oven is too hot or too cold, you can adjust the temperature yourself to meet your specific cooking preference.
Food does not bake properly	Oven controls improperly set.	See the Cooking Modes section.
	Rack position is incorrect or rack is not level.	See the Cooking Modes section and Cooking Guide.
	Incorrect cookware or cookware of improper size being used.	See the Cookware section.
	Oven temperature needs adjustment.	See the Special Features section.
	Ingredient substitution	Substituting ingredients can change the recipe outcome.
Food does not broil properly	Oven controls improperly set.	Make sure you select the appropriate broil mode.
	Improper rack position being used.	See Cooking Guide for rack location suggestions.
	Food being cooked in a hot pan.	Make sure cookware is cool.
	Cookware not suited for broiling.	Use a pan specifically designed for broiling.
	Aluminum foil used on the broiling pan and grid has not been fitted properly and slit as recommended.	If using aluminum foil conform to pan slits.
	In some areas the power (voltage) may be low.	Preheat the broil element for 10 minutes.
Oven temperature too hot or too cold	Oven temperature needs adjustment.	See the Special Features section.
Oven does not work or appears not to work	A fuse in your home may be blown or the circuit breaker tripped.	Replace the fuse or reset the circuit breaker.
	Oven controls improperly set.	See the Using the Oven section.
	Oven is in Sabbath Mode.	Verify, that the oven is not in Sabbath Mode. See the Special Features section.
"Crackling" or "popping" sound	This is the sound of the metal heating and cooling during both the cooking and cleaning functions.	This is normal.
Why is my range making a "clicking" noise when using my oven?	Your range has been designed to maintain a tighter control over your oven's temperature. You may hear your oven's heating elements "click" on and off more frequently than in older ovens to achieve better results during baking, broiling, and self-clean cycles.	This is normal.
Clock and timer do not work	A fuse in your home may be blown or the circuit breaker tripped.	Replace the fuse or reset the circuit breaker.
Sometimes the oven takes longer to preheat to the same temperature	Cookware or food in oven	The cookware or food in the oven will cause the oven to take longer to preheat. Remove items to reduce preheat time.
	Number of racks in oven	Adding more racks to the oven will cause the oven to take longer to preheat. Remove some racks.

Troubleshooting tips ... Before you call for service

Problem	Possible Cause	What To Do
Oven light does not work	Light bulb is loose or defective.	Tighten or replace bulb.
	Pad operating light is broken.	Call for service.
Oven will not self-clean	The temperature is too high to set a self-clean operation.	Allow the oven to cool and reset the controls.
	Oven controls improperly set.	See the Cleaning the Oven section.
Excessive smoking during clean cycle	Excessive soil or grease..	Press the Cancel/Off pad. Open the windows to rid the room of smoke. Wait until the  goes off. Wipe up the excess soil and reset the clean cycle.
Excessive smoking during broiling	Food too close to burner element.	Lower the rack position of the food.
Oven door will not open after a clean cycle	Oven too hot.	Allow the oven to cool below locking temperature.
Oven not clean after a clean cycle	Oven controls improperly set.	See the Cleaning the Oven section.
	Oven was heavily soiled.	Clean up heavy spillovers before starting the clean cycle. Heavily soiled ovens may need to self-clean again or for a longer period of time.
 flashes in the display	The self-clean cycle has been selected but the door is not closed.	Close the oven door.
 is on when you want to cook	The oven door is locked because the temperature inside the oven has not dropped below the locking temperature.	Press the Cancel/Off pad. Allow the oven to cool.
“F— and a number or letter” flash in the display	You have a function error code.	Press the Cancel/Off pad. Allow the oven to cool for one hour. Put the oven back into operation.
	If the function code repeats.	Disconnect all power to the oven for at least 30 seconds and then reconnect power. If the function error code repeats, call for service.
Display goes blank	A fuse in your home may be blown or the circuit breaker tripped.	Replace the fuse or reset the circuit breaker.
	The clock is turned off.	See the Special features section.
	Oven is in Sabbath Mode.	Verify that the oven is not in Sabbath Mode. See the Special Features section.
Power outage, clock flashes	Power outage or surge	Reset the clock. If the oven was in use, you must reset it by pressing the Cancel/Off pad, setting the clock and resetting any cooking function.
“Burning” or “oily” odor emitting from the vent	This is normal in a new oven and will disappear in time.	To speed the process, set a self-clean cycle for a minimum of 3 hours. See the Cleaning the Oven section. This is temporary.
Strong odor	An odor from the insulation around the inside of the oven is normal for the first few times the oven is used.	This is temporary and will go away after several uses or a self-clean cycle.
Fan noise	A cooling fan may automatically turn on.	This is normal. The cooling fan will turn on to cool internal parts. It may run for up to 1-1/2 hours after the oven is turned off.
My oven door glass appears to be “tinted” or have a “rainbow” color. Is this defective?	No. The inner oven glass is coated with a heat barrier to reflect the heat back into the oven to prevent heat loss and keep the outer door cool while baking.	This is normal. Under certain light or angles, you may see this tint or rainbow color.
Oven will not work remotely	Router issues, no wireless signal, etc.	For assistance with oven wireless network connectivity, please call 800.220.6899.
	Oven is not connected.	

GE Appliances Electric Oven Limited Warranty

GEAppliances.com

All warranty service is provided by our Factory Service Centers, or an authorized Customer Care® technician. To schedule service online, visit us at GEAppliances.com/service_and_support/, or call GE Appliances at 800.GE.CARES (800.432.2737). Please have your serial number and your model number available when calling for service.

Servicing your appliance may require the use of the onboard data port for diagnostics. This gives a GE Appliances factory service technician the ability to quickly diagnose any issues with your appliance and helps GE Appliances improve its products by providing GE Appliances with information on your appliance. If you do not want your appliance data to be sent to GE Appliances, please advise your technician not to submit the data to GE Appliances at the time of service.

For the period of	GE Appliances will replace
One year From the date of the original purchase	Any part of the oven which fails due to a defect in materials or workmanship. During this limited one-year warranty , GE Appliances will provide, free of charge , all labor and in-home service to replace the defective part.

What GE Appliances will not cover:

- Service trips to your home to teach you how to use the product.
- Improper installation, delivery or maintenance.
- Failure of the product if it is abused, misused, modified or used for other than the intended purpose or used commercially.
- Replacement of house fuses or resetting of circuit breakers.
- Damage to the product caused by accident, fire, floods or acts of God.
- Damage to finish, such as surface rust, tarnish, or small blemishes not reported within 48 hours of delivery.
- Incidental or consequential damage caused by possible defects with this appliance.
- Damage caused after delivery.
- Product not accessible to provide required service.
- Service to repair or replace light bulbs, except for LED lamps.

EXCLUSION OF IMPLIED WARRANTIES

Your sole and exclusive remedy is product repair as provided in this Limited Warranty. Any implied warranties, including the implied warranties of merchantability or fitness for a particular purpose, are limited to one year or the shortest period allowed by law.

Staple your receipt here. Proof of the original purchase date is needed to obtain service under the warranty.

This limited warranty is extended to the original purchaser and any succeeding owner for products purchased for home use within the USA. If the product is located in an area where service by a GE Appliances Authorized Servicer is not available, you may be responsible for a trip charge or you may be required to bring the product to an Authorized GE Appliances Service location for service. In Alaska, the limited warranty excludes the cost of shipping or service calls to your home.

Some states do not allow the exclusion or limitation of incidental or consequential damages. This limited warranty gives you specific legal rights, and you may also have other rights which vary from state to state. To know what your legal rights are, consult your local or state consumer affairs office or your state's Attorney General.

Warrantor: GE Appliances, a Haier company

Louisville, KY 40225

Extended Warranties: Purchase a GE Appliances extended warranty and learn about special discounts that are available while your warranty is still in effect. You can purchase it online anytime at

GEAppliances.com/extended-warranty

or call 800.626.2224 during normal business hours. GE Appliances Service will still be there after your warranty expires.

Accessories

Looking For Something More?

GE Appliances offers a variety of accessories to improve your cooking and maintenance experiences!

Refer to the Consumer Support page for phone numbers and website information.

The following products and more are available:

Accessories

Small Broiler Pan (8 ¾" x 1 ¼" x 13 ½")

Large* Broiler Pan (12 ¾" x 1 ¼" x 16 ½")

XL** Broiler Pan (17" x 1 ¼" x 19 1/4")

Parts

Oven racks

27" Never Scrub Glide Rack

30" Never Scrub Glide Rack

Oven elements

Light bulbs

Cleaning Supplies

CitruShine™ Stainless Steel Wipes

CeramaBryte Stainless Steel Appliance Cleaner

Graphite Lubricant***

*The large broiler pan does not fit in 20"/24" ranges.

**The XL broiler pan does not fit in 24" wall ovens, 27" drop ins or 20"/24" ranges.

***For use with Never Scrub glide racks.

Consumer Support

GE Appliances Website

Have a question or need assistance with your appliance? Try the GE Appliances Website 24 hours a day, any day of the year! You can also shop for more great GE Appliances products and take advantage of all our on-line support services designed for your convenience. In the US: GEAppliances.com

Register Your Appliance

Register your new appliance on-line at your convenience! Timely product registration will allow for enhanced communication and prompt service under the terms of your warranty, should the need arise. You may also mail in the pre-printed registration card included in the packing material. In the US: GEAppliances.com/register

Schedule Service

Expert GE Appliances repair service is only one step away from your door. Get on-line and schedule your service at your convenience any day of the year. In the US: GEAppliances.com/service or call 800.432.2737 during normal business hours.

Extended Warranties

Purchase a GE Appliances extended warranty and learn about special discounts that are available while your warranty is still in effect. You can purchase it on-line anytime. GE Appliances Services will still be there after your warranty expires. In the US: GEAppliances.com/extended-warranty or call 800.626.2224 during normal business hours.

Remote Connectivity

For assistance with wireless network connectivity (for models with remote enable), visit our website at GEAppliances.com/connect or call 800.220.6899 in the US.

Parts and Accessories

Individuals qualified to service their own appliances can have parts or accessories sent directly to their homes (VISA, MasterCard and Discover cards are accepted). Order on-line today 24 hours every day. In the US: GEApplianceparts.com or by phone at 877.959.8688 during normal business hours.

Instructions contained in this manual cover procedures to be performed by any user. Other servicing generally should be referred to qualified service personnel. Caution must be exercised, since improper servicing may cause unsafe operation.

Contact Us

If you are not satisfied with the service you receive from GE Appliances, contact us on our Website with all the details including your phone number, or write to:

In the US: General Manager, Customer Relations | GE Appliances, Appliance Park | Louisville, KY 40225
GEAppliances.com/contact