

NAPOLEON®

BUILT-IN GRILLS

EXPERTS IN GAS & INFRARED GRILLING



napoleongrills.com





THE STORY

It all began in 1976 when a small steel fabrication business launched by Wolfgang Schroeter started manufacturing steel railings in Barrie, Ontario, Canada. At that time, no one could imagine the incredible future that lay ahead for Wolf Steel Ltd. and eventually Napoleon® Fireplaces and Napoleon® Gourmet Grills. Since the first wood stove rolled off the production line over 36 years ago, Wolf Steel's commitment was to be distinctive and successful in everything they do. The original stove featured a solid cast iron two-door design and was produced in a one thousand square foot manufacturing facility. By 1981, the name "Napoleon" was born and with it, the first single glass door with Pyroceram high temperature ceramic glass – a first in the industry. This was the first of many milestones for Wolf Steel Ltd and over the next few years, the demand for Napoleon's wood stoves grew beyond Ontario's borders to the rest of Canada, the United States, Europe and the United Kingdom. Napoleon® is an ISO9001 – 2008 registered company and operates with 750,000+ square feet of manufacturing space and over 700 employees. Napoleon® is North America's largest privately owned manufacturer of quality wood and gas fireplaces (inserts and stoves), gourmet gas and charcoal grills, outdoor living products, waterfalls and a complete line of HVAC equipment.



CREATIVE SPIRIT, PERFORMANCE & QUALITY

A passionate dedication to grilling.

Napoleon®, a two generation family owned Canadian company, has been providing home products for over 36 years, committed to designing and manufacturing only the finest high efficiency grills, fireplaces and outdoor living products you can depend on.... Proudly backed by the President's Limited Lifetime Warranty.

Superior technology, rock solid performance, balanced design and unparalleled customer service are the hallmark of the Napoleon® name. Your Napoleon® grill is designed to excel, offering a cooking experience as gratifying as the wonderful meals you'll create with it.

In the pages ahead, you'll discover the beauty and simplicity of Napoleon® style - the ideal complement to your patio environment.

Wishing you many unforgettable meals - grilled to perfection.

PRESTIGE PRO™

BIPRO600RBI

Up to 82,500 BTU's
5 burners
Cooking Area: 922 in²
Cart model available



 Proudly Made in Canada



Infrared SIZZLE ZONE™
Bottom Burner

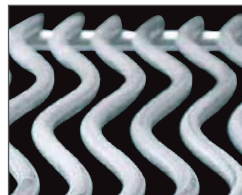

9.5 mm Stainless Steel
WAVE™ Cooking Grids



Electronic Ignition



Rear Infrared
Rotisserie Burner

INFRARED
SIZZLE
ZONE™



CEDAR PLANKED SALMON WITH SCALLOP CRUST

- 4 Atlantic Salmon fillets (10-12 oz), pin-bones and skin removed
- ¼ cup (60 mL) Country Herb Spice

Crust

- 1 large red onion, finely diced
- ½ cup (125 mL) thinly sliced green onion
- ¼ cup (60 mL) chopped fresh dill
- 3 cloves garlic, minced
- ¼ cup (60 mL) Fire Roasted Garlic Sauce
- 1 tbsp. (15 mL) Country Herb Spice
- 8-10 pieces fresh scallops (1 lb / 454 g)
- to taste, coarsely ground black pepper
- 1 lemon, cut into wedges
- 1 - 12" Cedar Plank soaked in water for one hour minimum

INFRARED TECHNOLOGY

The intense heat of Napoleon's infrared technology instantly locks in the juices for an amazing taste sensation! Over 11,000 flame ports produce up to 1500°F for optimum searing. See page 19 for more details.

PRESTIGE PRO™

BIPRO500RB

Up to 66,000 BTU's
5 burners
Cooking Area: 760 in²
Cart model available



Commercial quality rotisserie kit with counter balance and 4 forks for delicious restaurant style cooking using the rear infrared burner

Heavy gauge, long lasting stainless steel tube burners with crossover lighting

Available as a natural gas or propane unit

Deluxe high top, space saving LIFT EASE™ roll top lid with polished chrome trim accents and handle

Engaging i-GLOW™ backlit control knobs for late night entertaining

Drop-in Side Burner
Natural Gas and Propane Available

Flush Mount Stainless Steel Double Door
N370-0503

Doors and drawers are optional. Island not included.

Proudly Made in Canada

Preheat grill to medium-high heat.

Rub salmon all over with Country Herb Spice, gently pressing the spices into the meat. Place the salmon, evenly spaced, on the plank.

In a large bowl combine red onion, green onion, dill, garlic, Fire Roasted Garlic Sauce and Country Herb Spice. Mix well and divide topping evenly onto the salmon fillets, gently pressing topping into the fillets to adhere.

Using a sharp knife, slice the scallops into 4 round slices. Season scallops with coarsely ground black pepper to taste. Arrange 6-8 scallop slices evenly onto each salmon on top of the red onion crust.

Carefully place the plank on the grill and close the lid.

Plank grill for 12-15 minutes, or until salmon is just cooked through and the scallops are golden.

Remove plank from grill and serve immediately with wedges of lemon and extra Fire Roasted Garlic Sauce on the side.

Serves 4

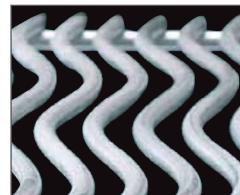

9.5 mm Stainless Steel WAVE™ Cooking Grids



Dual-Level, Stainless Steel Sear Plates



i-GLOW™ Backlit Control Knobs

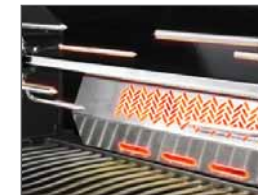

Rear Infrared Rotisserie Burner



CHARCOAL FLAVOUR FROM YOUR GAS GRILL

Napoleon's optional charcoal tray is designed to let you add the fun & flavour of charcoal anytime, on your gas grill. Simply replace sear plates with the charcoal tray, add charcoal and light with your gas burner. For more details see page 18.



PRESTIGE® II

BIPT750RBI GEMINI™

Up to 92,500 BTU's
6 burners
Cooking Area: 1160 in²
Cart model available



Doors and drawers are optional. Island not included.

Proudly Made in Canada

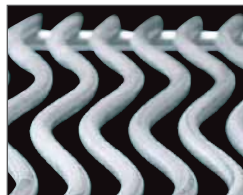

9.5 mm Stainless Steel
WAVE™ Cooking Grids



Infrared SIZZLE ZONE™
Bottom Burners



Electronic Ignition



Rear Infrared
Rotisserie Burner

INFRARED
SIZZLE
ZONE™

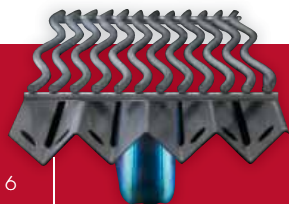

HEAVY DUTY STAINLESS STEEL COOKING SYSTEM

The even, consistent heat from high and hot to low and slow. WAVE™ cooking grids for those trademark Napoleon® sear lines, self cleaning sear plates for reduced flare-ups and durable burners for controlled, even heat.

CHICKEN THIGHS WITH SOY WASABI GLAZE

- 12 chicken thighs, skin on & bone in
- Savory Chicken and Rib Spice

Soy Wasabi Glaze

- 2 tbsp. (30 mL) vegetable oil
- 1 tsp. (5 mL) sesame oil
- 4 cloves garlic, minced
- 1 tbsp. (15 mL) finely chopped ginger
- ½ cup (125 mL) soy sauce
- ¼ cup (60 mL) honey
- 2 tbsp. (30 mL) rice vinegar
- 1 tbsp. (15 mL) Wasabi powder
- to taste, salt and coarsely ground pepper
- ¼ cup (60 mL) toasted sesame seeds
- ½ cup (125 mL) pickled ginger



Pat chicken thighs dry with paper toweling. Season the chicken with Chicken and Rib Spice, pressing the seasoning into the meat.

To prepare the glazing sauce, place the vegetable oil and sesame oil in a medium saucepan over medium-high heat. Sauté the garlic and ginger until tender and fragrant, about 3 to 4 minutes. Stir in the soy sauce, honey and rice vinegar. Bring to a boil, reduce heat to low and simmer for 10 minutes. Remove from heat and whisk in Wasabi powder. Set aside and allow to cool.

Preheat grill to medium-high heat.

Spray chicken lightly with non-stick cooking spray and place onto grill. Sear chicken thighs for 2 to 3 minutes per side. Transfer chicken thighs to the top rack of the grill, turn grill down to medium heat and close lid. Roast chicken thighs for 20 to 30 minutes over indirect heat basting every 10 minutes with lots of the glazing sauce. Baste chicken thighs one final time with glaze and remove from grill.

Sprinkle chicken with toasted sesame seeds and serve with pickled ginger and extra glazing sauce on the side.

Serves 6

PRESTIGE® BIP500

Up to 48,000 BTU's
4 burners
Cooking Area: 760 in²
Cart model available

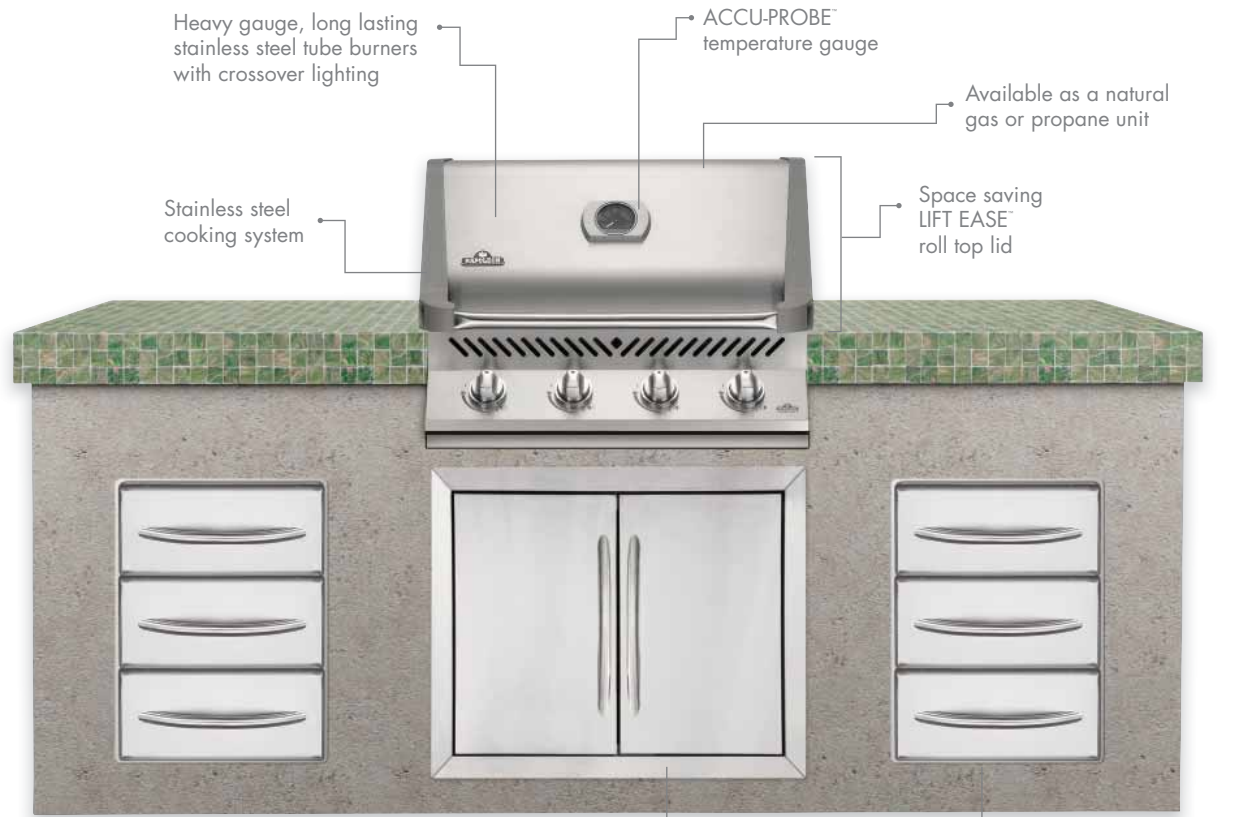

Heavy gauge, long lasting stainless steel tube burners with crossover lighting

ACCU-PROBE™ temperature gauge

Available as a natural gas or propane unit

Stainless steel cooking system

Space saving LIFT EASE™ roll top lid

Doors and drawers are optional. Island not included.

Flush Mount Stainless Steel Double Door N370-0502

Flat Stainless Steel Triple Drawer Kit N370-0502

 Proudly Made in Canada

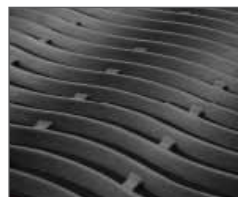

Porcelainized Cast Iron WAVE™ Reversible Channel Cooking Grids



Dual-Level, Stainless Steel Sear Plates



JETFIRE™ Ignition



ACCU-PROBE™ Temperature Gauge



DUAL-LEVEL STAINLESS STEEL SEAR PLATES

Dual-Level, individual stainless steel sear plates allow consistent, even heat and continuous grease run off. (Available on BIPRO500RB & BIP500)



PRESTIGE V™

BIPF600

Up to 106,500 BTU's
7 burners
Cooking Area: 1100 in²
Cart model available

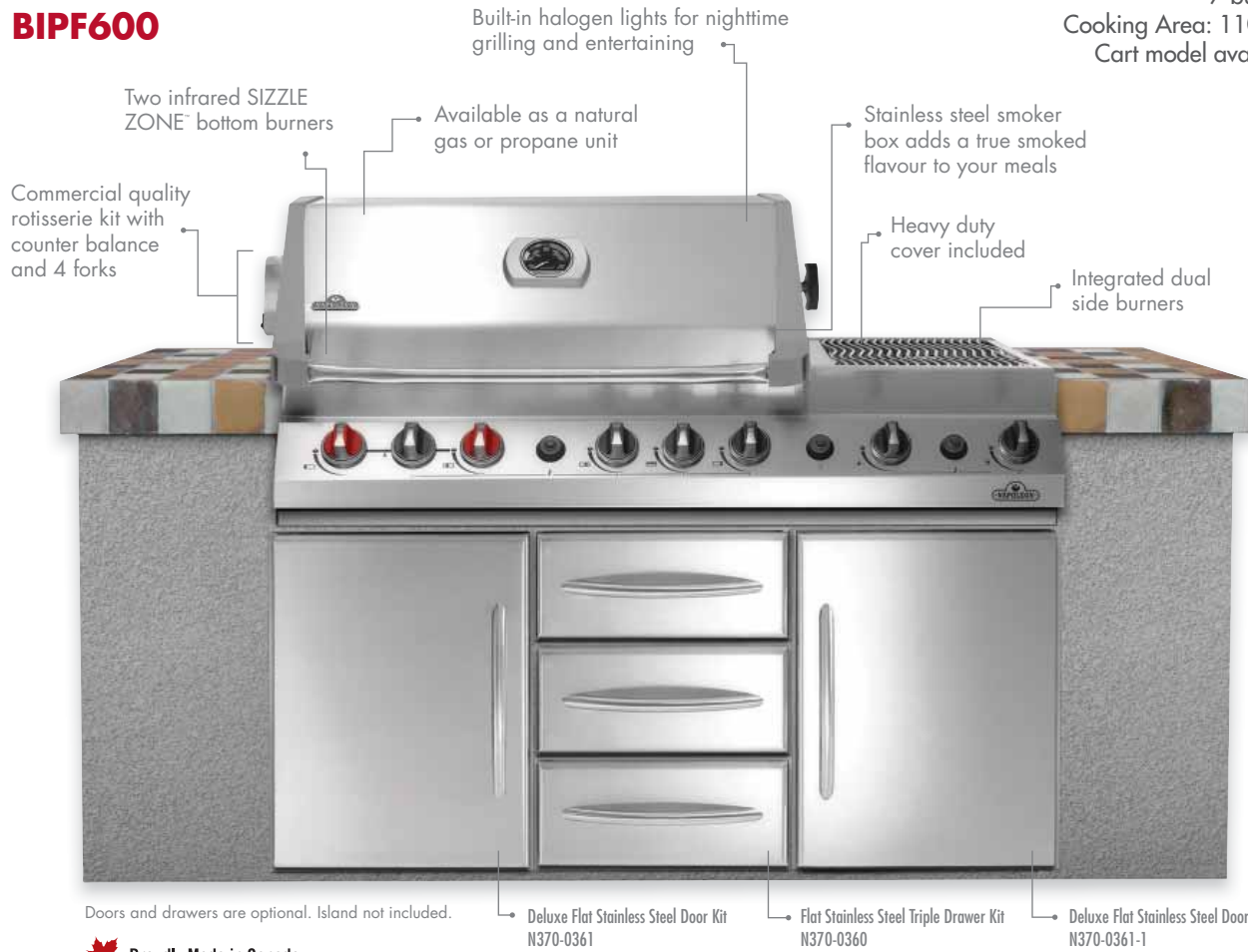

Doors and drawers are optional. Island not included.

 Proudly Made in Canada



Stainless Steel Smoker Box



Built-in Halogen Lights



Integrated Dual Side Burners



Ceramic Rear Infrared Rotisserie Burner

INFRARED
**SIZZLE
ZONE**



ACCU-PROBE™ TEMPERATURE GAUGE

Safely and instantly read the internal temperature of your grill with the lid closed. This thermometer has a wide temperature measurement range from 0° to 370°C (0° to 700°F) and includes the ideal smoking and searing range.

TANDOORI LAMB CHOPS WITH RAITA DUNK

- 2 lamb racks, frenched (5 to 7 ribs each)

Marinade

- 1 jar 300 mL Tandoori Injector Sauce
- ½ cup (125 mL) chopped fresh mint
- ¼ cup (60 mL) olive oil
- 2 tbsp. (30 mL) lime juice

Raita Dunk

- 1 small red onion, finely diced
- ½ seedless cucumber, peeled and finely diced
- 1 clove fresh garlic, minced
- 1 cup (250 mL) plain yogurt
- 2 tbsp. (30 mL) lime juice
- 1 tbsp. (15 mL) chopped fresh mint
- to taste, salt and coarsely ground black pepper



PRESTIGE V™

BIPF450

Up to 85,500 BTU's
6 burners
Cooking Area: 890 in²
Built-in model available

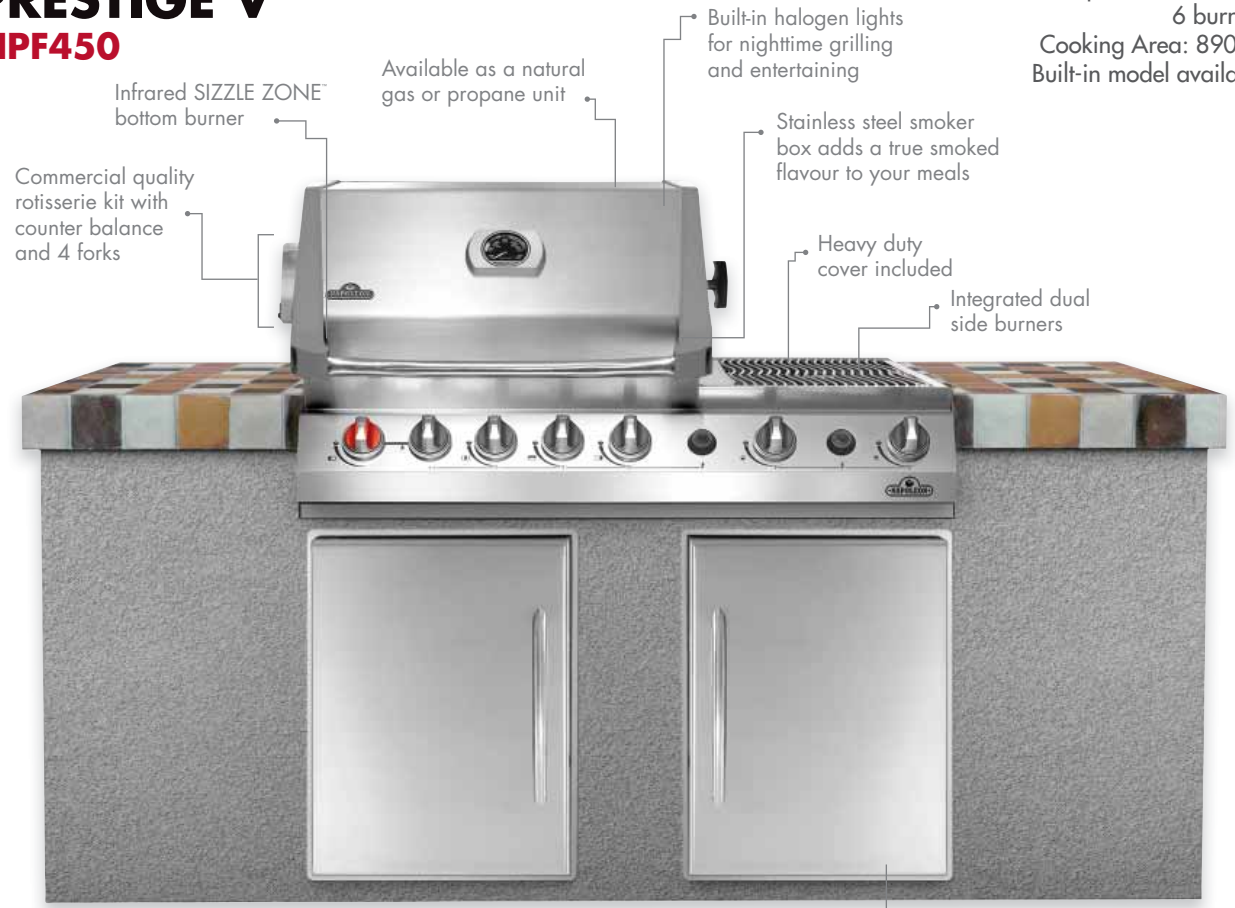

Doors and drawers are optional. Island not included.

Deluxe Flat Stainless Steel Door Kit
N370-0361-1

 Proudly Made in Canada

Using a sharp heavy knife, cut between every bone to form chops about ¾" thick.

Place Tandoori Injector Sauce, chopped fresh mint, olive oil and lime juice into a medium bowl and whisk to combine. Place chops into a sealable plastic bag, pour in marinade, seal bag and place into refrigerator to marinate for 2-3 hours, turning occasionally.

In a medium-sized mixing bowl, mix red onion, diced cucumber, minced garlic, yogurt, lime juice and mint. Season to taste with salt and coarsely ground black pepper. Cover and refrigerate until needed.

Preheat grill to medium-high heat.

Remove chops from the marinade. Carefully shake off excess marinade and place lamb chops onto grill. Grill lamb chops for 2 to 3 minutes per side, for medium rare doneness, basting continuously with extra marinade.

Remove from the grill and allow to cool for 1 minute. Serve immediately with Raita Dunk.

Serves 2 as a main course

4 to 6 as an appetizer



Stainless Steel Smoker Box



Built-in Halogen Lights



Integrated Dual Side Burners



Ceramic Rear Infrared Rotisserie Burner

INFRARED
SIZZLE ZONE™



CERAMIC REAR INFRARED ROTISSERIE BURNER

Ceramic rear rotisserie burner heat waves seal and lock in the juices quickly for superior tenderness. Restaurant style results and perfect self-basting roasts every time. (Heavy duty rotisserie kit with counter balance, stainless steel rotisserie bracket and forks available with most models).

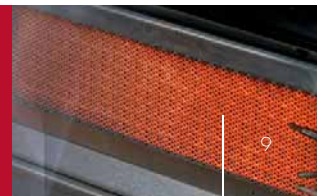

ULTRA CHEF® BIU405RB

Up to 59,000 BTU's
4 burners
Cooking Area: 570 in²
Cart model available

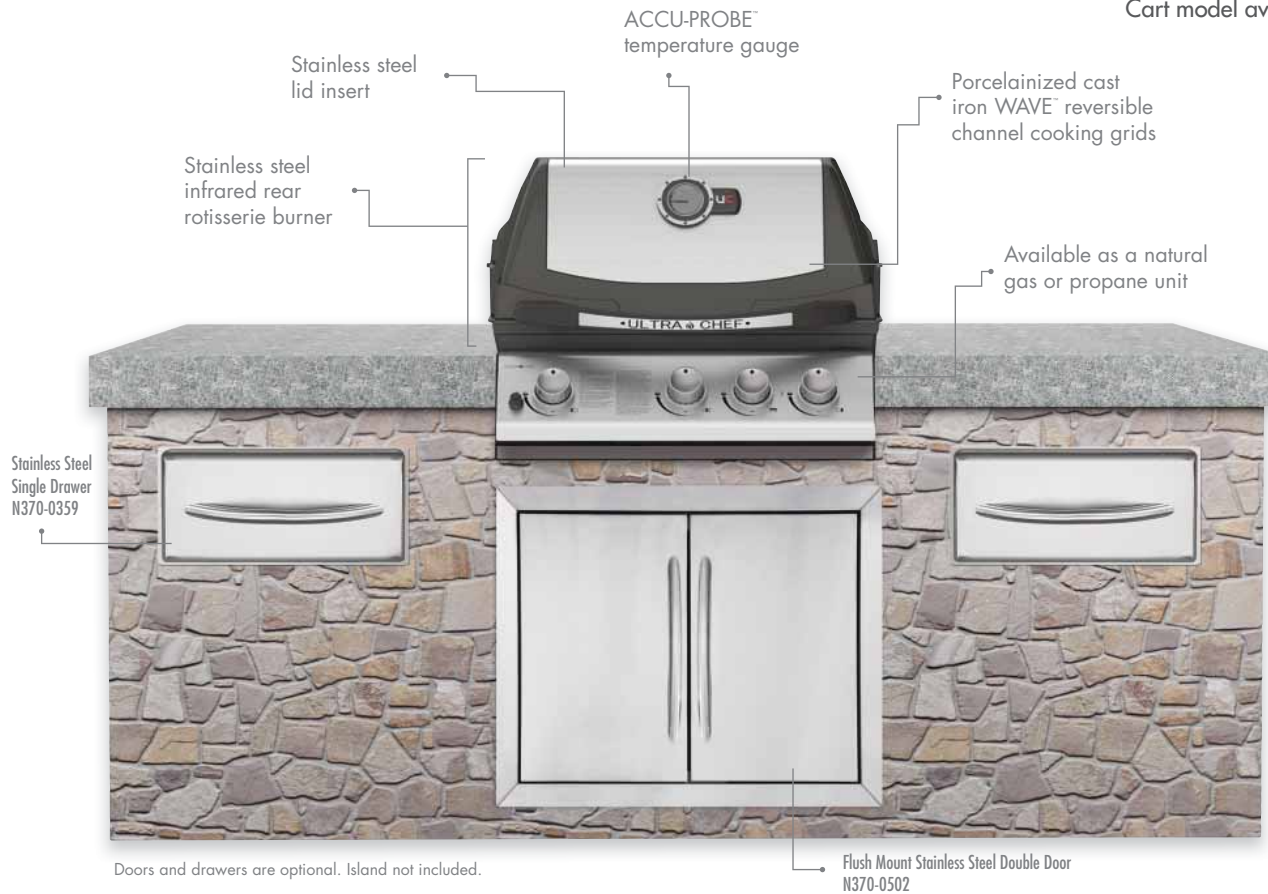

Doors and drawers are optional. Island not included.



ACCU-PROBE™
Temperature Gauge

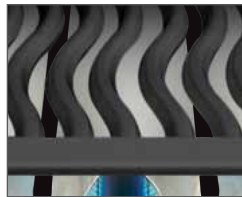

Porcelainized Cast
Iron WAVE™ Reversible
Channel Cooking Grids



Electronic Ignition

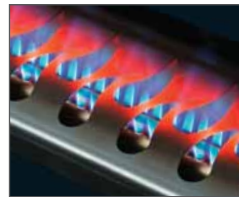

Rear Infrared
Rotisserie Burner



STUFFED PORK CHOP

- 4 Bone-In Pork Loin Chops - 2" thick (10-12 oz, 300-360 g)
- 2 tbsp. (30 mL) Creole Cajun Seasoning

Stuffing

- 2 slices multi-grain bread - toasted, cooled, and cut into ½" cubes (about 3 cups/750 mL diced)
- 1 cup (250 mL) ground sausage meat, breakfast style
- ½ cup (125 mL) finely diced white onion
- ¼ cup (60 mL) finely diced celery
- ¼ cup (60 mL) Sauvignon Blanc
- ¼ cup (60 mL) Napoleon® Fire Roasted Garlic Sauce
- ½ cup (125 mL) shredded mozzarella cheese
- 1 tbsp. (15 mL) chopped fresh thyme
- 15 mL (1 tbsp.) chopped fresh sage
- 30 mL (2 tbsp.) Creole Cajun Seasoning

STAINLESS STEEL TUBE BURNERS

Tube burners run front to back for precise heat control, allowing for independent use of each cooking zone for direct or indirect cooking.

MIRAGE™ SERIES

BIM730RBI, BIM605RBI & BIM485RB

Up to 96,000 BTU's
Up to 6 burners
Cooking Area: up to 1025 in²
Cart Models Available

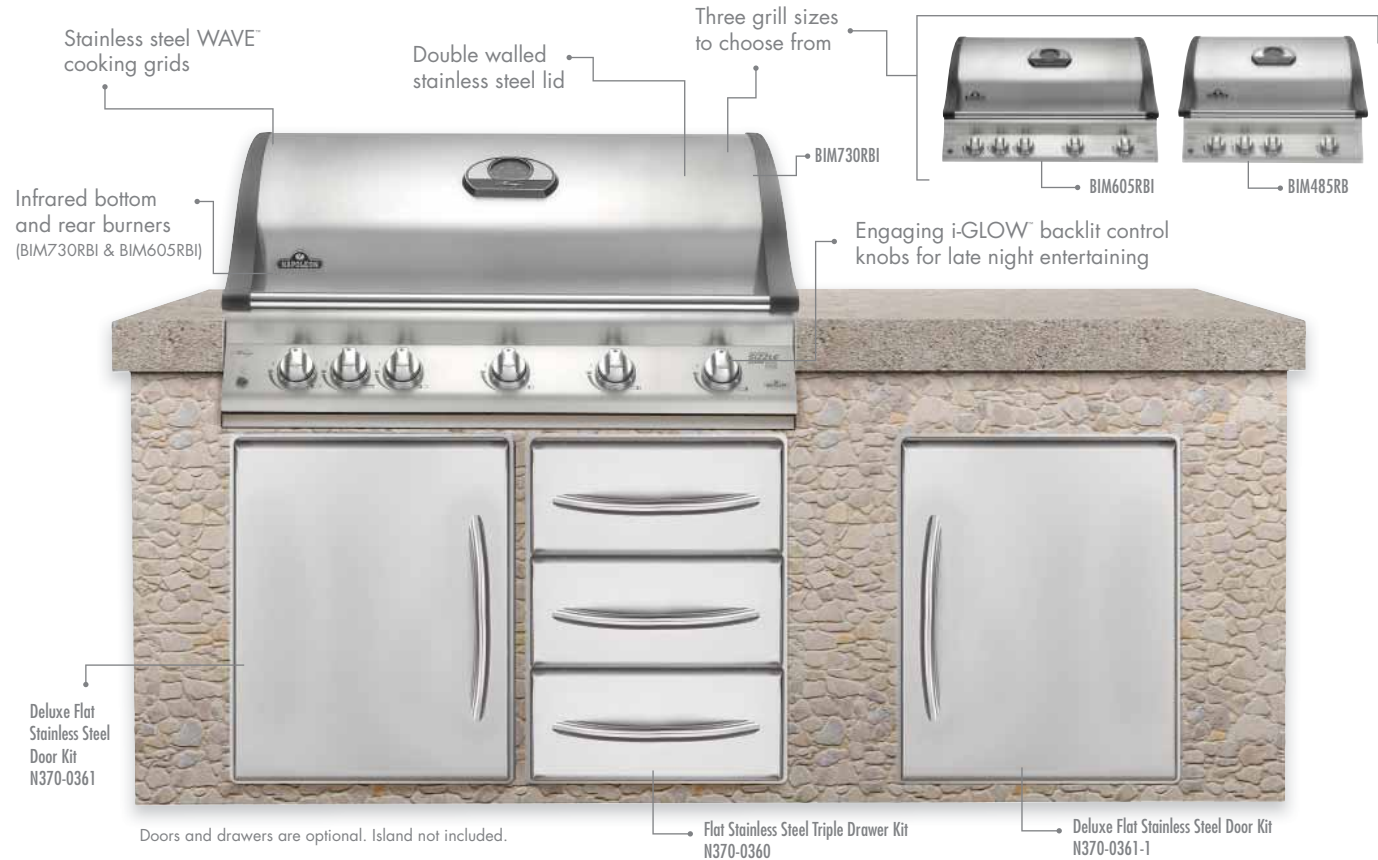

In a large bowl, combine cubed bread, ground sausage, diced onion, diced celery, Sauvignon Blanc, Fire Roasted Garlic Sauce, shredded mozzarella cheese, chopped fresh thyme, chopped fresh sage, and Creole Cajun Seasoning. Mix well.

Using a sharp knife, make a 2-3" deep incision on the side of each pork chop to form a pocket in the center, taking care not to cut through the other side.

Stuff each pork chop with about ½ – ¾ cup of the stuffing mixture, packing stuffing tightly into each pocket. Season pork chops with Creole Cajun Seasoning, pressing the seasoning into the meat to adhere. Place stuffed pork chops onto a tray, cover and refrigerate for a minimum of one hour to allow the stuffing to set.

Preheat grill to medium heat.

Grill pork chops for 10-12 minutes, turning once, until lightly charred. Move chops to top rack of grill, close lid and allow to roast for an additional 8-10 minutes, turning every 2 minutes and basting with Fire Roasted Garlic Sauce, or until pork is fully cooked and stuffing is hot throughout. Remove from grill and allow to cool for 1-2 minutes. Serve immediately with extra Fire Roasted Garlic Sauce on the side.

Serves 4

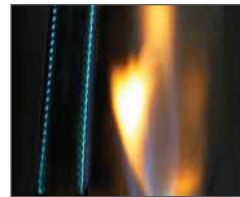

JETFIRE™ Ignition



i-GLOW™ Backlit Control Knobs



Ceramic Infrared Rear Burner
(BIM730RBI & BIM605RBI)

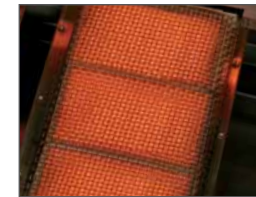

Infrared SIZZLE ZONE™ Bottom Burner
(BIM730RBI & BIM605RBI)

INFRARED
SIZZLE ZONE™



OVEN-LIKE PERFORMANCE

Napoleon's LIFT EASE™ roll top lid tucks neatly back giving you more space on your patio or deck. The tightly sealed lid will not be compromised by prevailing winds. Maximum heat is retained in the streamlined, double-walled lid for oven-like performance.





— NAPOLEON —
**EXPERTS IN
 GAS & INFRARED
 GRILLING**

OASIS™ MODULAR ISLANDS

ENDLESS CONFIGURATION POSSIBILITIES

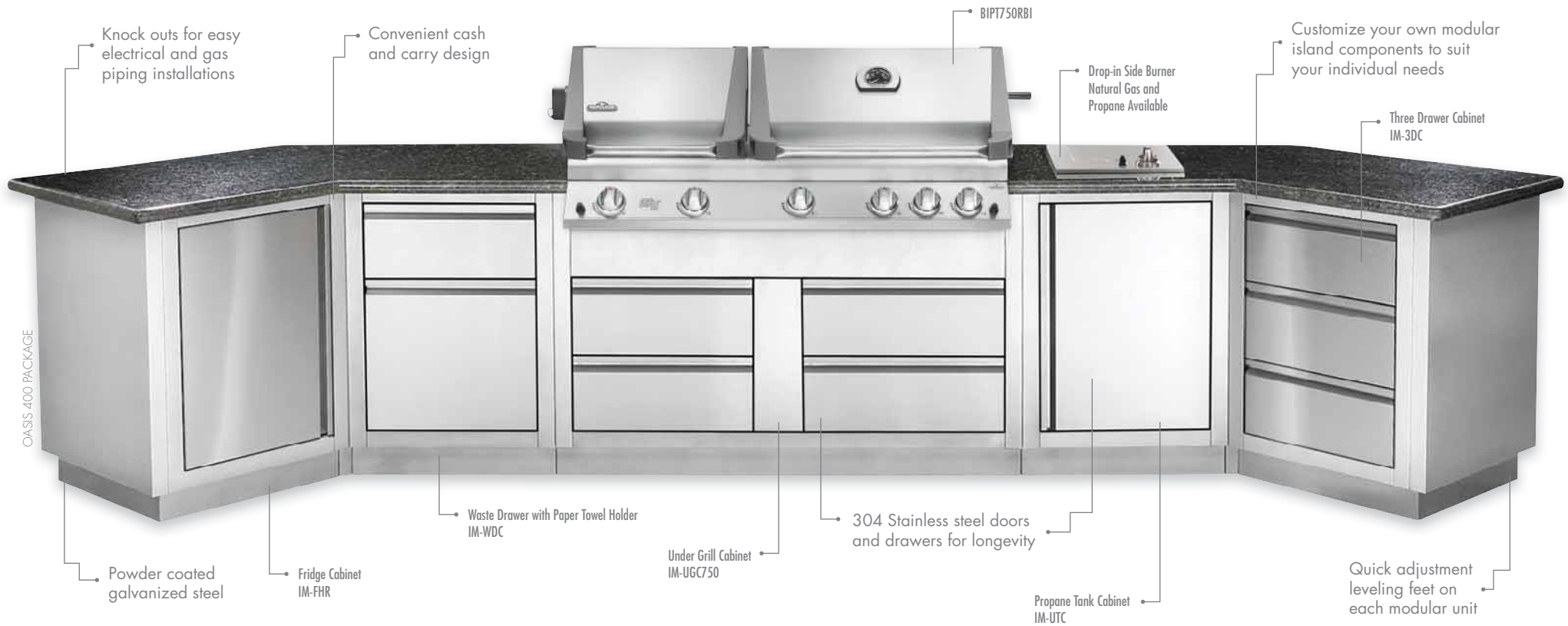

Built-in grill heads available for your custom Oasis island



BIP500



BIPRO500RB



BIPRO600RBI



BIPT750RBI



BIM485RB



BIM605RBI



BIM730RBI

PERSONALIZE YOUR OUTDOOR LIVING SPACE WITH THE LUXURIOUS OASIS™ MODULAR ISLANDS

Choose the modules that fit your lifestyle and your budget. The Napoleon® Oasis™ Modular Island series has been developed with versatility in mind. The cabinets can be assembled in virtually any combination to suit your individual needs. All cabinets are 35" tall and 24" deep with 4 leveling feet for easy adjustment on any surface. The Oasis™ Outdoor Modular island series can be assembled against any non-combustible wall of your home or as a standalone island.

OASIS™ MODULAR ISLAND COMPONENTS



Under Grill Cabinets
IM-UGC500, IM-UGC600, IM-UGC485,
IM-UGC605, IM-UGC730



Under Grill Cabinets
IM-UGC300
Fits side burners BISZ300, BISZ300FT, BISB245



Under Grill Cabinet
IM-UGC750



Three Drawer Cabinet
IM-3DC



Two Drawer Cabinet
IM-2DC



**Waste Drawer with
Paper Towel Holder**
IM-WDC



Propane Tank or Universal Cabinets
IM-UTC (Shown), IM-UDC
Left or right opening



Fridge Cabinet
IM-FHR, IM-FHL
Includes Danby 2.5 cu.ft general purpose fridge



Wall Spacer
IM-WSF



Cabinet Transitions
IM-45T = 45°



Cabinet End Panel
IM-CEP

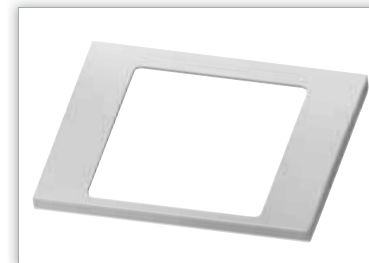

Ice Bucket Holder
IM-IBA



FINDING THE PERFECT STEAK

When buying a large steak, choose one that has a uniform thickness of about 1 ½ inches. Buy a top quality cut that is well marbled to ensure tenderness. The better the quality of beef, the tastier your steak will be. For a quick sauce, jazz up store-bought BBQ sauce by adding chopped chilies, a little Worcestershire sauce, a splash of vinegar, some chopped fresh onions or garlic, or get creative.

— NAPOLEON —
**EXPERTS IN
GAS & INFRARED
GRILLING**



BUILT-IN ISLAND DOORS, DRAWERS & BURNERS



Deluxe Flat Stainless Steel Door Kit with Curved Stainless Steel Handle
N370-0361-1



Flush Mount Stainless Steel Double Door
N370-0502, N370-0503



Zero Clearance Kit
BIZC600
Fits BIPRO600RB



Deluxe Stainless Steel Triple Drawer with Curved Stainless Steel Handles
N370-0360



Deluxe Stainless Steel Single Drawer with Curved Stainless Steel Handle
N370-0359



Drop-in Side Burner
N370-0504 (LP), N370-0505 (NG)



Infrared SIZZLE ZONE[®] Side Burner
BISZ300 with LIFT EASE[®] Roll Top Lid



Infrared SIZZLE ZONE[®] Side Burner
BISZ300FT with Stainless Steel Flat Cover



Double Side Burner
BISB245FT

— **NAPOLEON** —
**EXPERTS IN
GAS & INFRARED
GRILLING**

ALL SEASON GRILLING

The secret to grilling success in any season, is preparation. Always locate your grill away from the wind in a well-ventilated location to ensure consistent heat. Don't let the heat escape by constantly lifting the lid to check; instead use your thermometer. And, don't be afraid to use the warming rack to keep food warm or to finish cooking, if the rest of your food continues to cook on the main burners.

EVERYDAY GRILLING ACCESSORIES



Cast Iron Charcoal/Smoker Tray
67731



Charcoal Baskets
67400



Charcoal Starter
67800

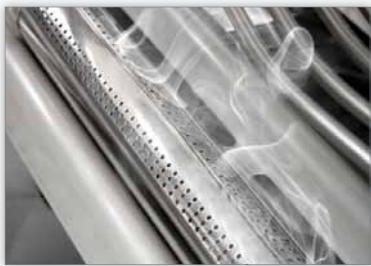

Smoker Pipe
67011



Cast Iron Griddles



Stainless Steel Griddles



3 in 1 Non-Stick Rib/Roast Rack
56011



Stainless Steel Rib & Roast Rack
70009



Multi-Grill Basket
57010

THE MOST VERSATILE COOKING STYLES AVAILABLE

Direct Cooking

This method of cooking utilizes all burners, cooking the food directly above the flame "GRILLING" style, for searing steaks, other meats or vegetables. Keeping the lid down reduces the cooking time and cooks through to the center faster than with the lid up. Anything that is less than 2 inches in thickness should be cooked by direct grilling. These are things that generally cook quickly and benefit from the fast cooking of a hot grill. Front to back burners were designed for precise heat control, allowing for independent use of each cooking zone.

Indirect Cooking

Indirect grilling is similar to baking. The food is placed above the unlit burner instead of directly over the flame. This can be achieved by only igniting some of the burners – light one side on high and cook the food on the other. The food will cook more evenly as it is not exposed to direct heat from the burners. This is an excellent way to cook tough cuts of meat, like brisket and ribs, that require long, slow cooking at a low or moderate heat. Indirect grilling allows you to work over a more moderate temperature (275° to 350°) and makes it easy to introduce a smoker pipe for extra flavour. For chicken, game, turkey, roasts, ham, vegetables, bread or combinations, the indirect cooking method gives great results every time. There is little need to turn the food. You can place the food directly on the grids or in a cooking pan.

Charcoal Cooking

Unique to Napoleon! Optional charcoal trays, give you the freedom to switch from gas to charcoal with relative ease. With charcoal you can utilize indirect cooking as well as direct cooking.

HERBS & SPICES

Dried herbs and spices make wonderful aromatics for grilling. Soak them for about 5 minutes, squeeze out the moisture, and sprinkle them either directly on the coals, or even in the water pan if you're cooking over indirect heat. Watch out for seeds, such as mustard and coriander. Heat makes them pop.

— NAPOLEON —
**EXPERTS IN
GAS & INFRARED
GRILLING**



Rotisserie Cooking

Rotisserie cooking allows the food to self-baste, sealing in the juices while browning the outside surface. Use the rotisserie method of cooking for large cuts of meat like roasts, poultry or legs of lamb. There are so many advantages to rotisserie cooking. Meats are generally juicier, self-basted and slow roasted. You can use the rotisserie method if your grill comes with a rear rotisserie burner, which requires much less attention than any other cooking method. The rotisserie burner is a nice feature because it automatically sets you up for direct, even heating.

Infrared Bottom Burner Cooking

Do you want to make the perfect steak? The intense 1500° heat instantly sears the meat, locking in the juices. Larger cuts of meat may be moved to the side of the grill to continue cooking.

Smoking

Place wet wood chips into the smoker tube and place over the left burner, then turn the burner on. Place your meat over the right burner, but do not turn on that burner. You are using the indirect cooking method. Smoke the meat for several hours under a closed lid. To achieve maximum flavour, fresh wood chips may be added several times during the cooking process.



Wok & Beer Can Chicken Roaster
56020



Stainless Steel Chicken Roaster
56021



Professional Cast Iron Skillet
56003



Rotisserie Shish Kebab Wheel
64007



Tumble Basket
64003



6 Stainless Steel Skewers - 14"
70016



Rotisserie Kits



Rotisserie Motors with Light



Drip Pans
62008

Visit napoleongrills.com to see Napoleon's complete line of grilling accessories.

— NAPOLEON —
**EXPERTS IN
GAS & INFRARED
GRILLING**

"DONENESS" TEST

Take your left forefinger and touch it to the tip of your left thumb. Don't apply pressure, just use the lightest touch with your finger, touching the base of the meaty part of your thumb. This feeling is similar to the consistency of rare steak. Now compare it by touching the steak. For medium done, use the second finger of your left hand to touch the tip of your left thumb. Well done, use the third finger of the left hand.

COOKING WITH CHARCOAL ON YOUR GAS GRILL

Charcoal is the traditional way of infrared cooking that we are all familiar with. It provides a feeling of nostalgia you can't escape with the smoky flavour you've loved for so long. The glowing briquettes emit infrared energy to the food being cooked, with very little drying effect.

At Napoleon®, we are proud experts in infrared grilling but as fans of all ways to grill we know you can't replace the experience and smoky flavour of grilling with charcoal.

As this is a bonus, we wanted to combine the two masters of grilling. With our charcoal trays you can now experience the smoky flavour and raw grilling of charcoal but with easier heat up, less mess and even heating on your gas grill.

Still want the convenience of gas, but long for that charcoal flavour?

No problem! Napoleon's charcoal tray lights easily with your

gas burner. Before you begin to use your charcoal tray, you will need to determine how much charcoal you are going to need to complete the meal. Approximately one layer for burgers or steaks and two layers for roasts or chicken. Pour enough charcoal into the tray to make the layers needed. Stack charcoal into a cone shape. Remove one sear plate, light the gas burner directly under the charcoal tray and burn on high until the charcoal is glowing red and then turn off the gas burner. Let coals burn until all coals are white on the surface. With a long handle instrument, spread the coals evenly across the coal grate. Close lid, wait 5 minutes and start cooking!

Tips: Never add lighter fluid to burning coals. Even if there is no flame, the heat will vaporize the lighter fluid and can cause a serious flare-up the second the vapor encounters a flame.



Want That Smoky Goodness?

Enjoy that delicious smoked meat flavour at home with your own grill and a few pointers from Napoleon®. When using gas grills, it's best to put presoaked wood chips in our smoker tube, available at Napoleon® grill retailers. This keeps your grill from filling up with ashes and clogging the jets. If you are using a charcoal tray, then you can either put the wood directly on the preheated coals or place them in a smoker tube. Experiment a little to find what works best for you.

Fill the stainless steel smoker tube with wood chips. Submerge in water for at least half an hour. Place the smoker tube over the left burner and turn it on. Place your meat over the right burner, but do not turn on the burner. You are using the indirect/smoking cooking method.

Smoke the meat for several hours under a closed lid. To achieve maximum flavour, add fresh, pre-soaked wood chips several times during the cooking process.

OVEN-LIKE PERFORMANCE

Your gas grill can also be used as a conventional or convection oven. Bread, buns, cakes and pizzas can be cooked to perfection under the grill lid. For convection cooking, follow the same instructions as for the indirect cooking method. Your grill comes with a tightly sealed lid for heat retention, giving oven-like performance.

— NAPOLEON —
**EXPERTS IN
GAS & INFRARED
GRILLING**

HOW DOES INFRARED COOKING WORK?

Since the discovery of fire, man-kind has been striving to improve taste and perfect the grilling experience. Infrared grilling is simply the relationship between the type of food, heat, and time. Infrared cooking uses high-efficiency radiant energy, much like the sun. High-frequency electromagnetic waves from the invisible end of the light spectrum travel from the infrared source to the food.

Napoleon® infrared grills use ceramic burners with thousands of evenly spaced flame ports to generate infrared radiant energy. The flame energy is absorbed by the ceramic, which then glows and heats up to an incredible 1500°F. This remarkable SIZZLE ZONE™ heat intensity quickly sears your food to lock in moisture and flavour. The results are unmistakable - succulent, flavourful food in a much-reduced grilling time! Napoleon's infrared grilling technology makes serving the perfect meal quick and easy each and every time.

Versatile

Grill anything like a professional, from steaks to seafood, fish to vegetables.

Great Retention of Flavour and Moisture

Infrared provides the heat necessary to lock in the juices with little or no preheating time. Radiant energy is delivered more directly to the food, and warms less air. Therefore, the food cooks very quickly, resulting in a greater retention of food weight. Food cooked in its own juices is more succulent, tender and tasty.

More Efficient

Infrared heats the object not the air so it cooks twice as fast as traditional burners while using less fuel. Because infrared heats food directly, not the air around it, grilling year round is much easier.

The Environmental Choice!

Because the infrared burners are ready to grill in under a minute and grilling time is drastically decreased, cooking your food with Napoleon's advanced infrared technology can reduce your gas consumption by up to 50%.

BTU/FUEL CONSUMPTION

TRADITIONAL
GRILLING

NAPOLEON®
INFRARED GRILLING

How To Cook The Perfect Infrared Steak

Pick a steak that is well marbled, the more marble there is inside, the more flavourful and tender your steak will be. A perfect steak size is about 1 ½ to 2 inches thick and about 12 to 16 ounces each, depending on the cut.

1. Lift lid of grill or side burner.
2. Ignite infrared burner.
3. Warm up for one minute.
5. Place thick, juicy steak on grids.
6. Wait two - three minutes, flip steak with tongs. (You do not want to use a fork and pierce the steak as this will let out the juices the infrared has locked in).
7. Wait another two - three minutes, turn off the red knob.
8. You now have a medium rare steak.

Bon Appetite.

Note: Never cut a steak to see if it is done - use a meat thermometer. Cutting allows all the natural juices to escape.

— NAPOLEON —
**EXPERTS IN
GAS & INFRARED
GRILLING**

TROUBLE-FREE GRILLING

If you take the time to give your grill a thorough check-up in the spring and once more in the fall, you will enjoy years of trouble-free grilling. If you can't fit both check-ups in, choose the springtime, just before the busy summer grilling season starts, to get at least one good check-up.

INSTALLATION SPECIFICATIONS

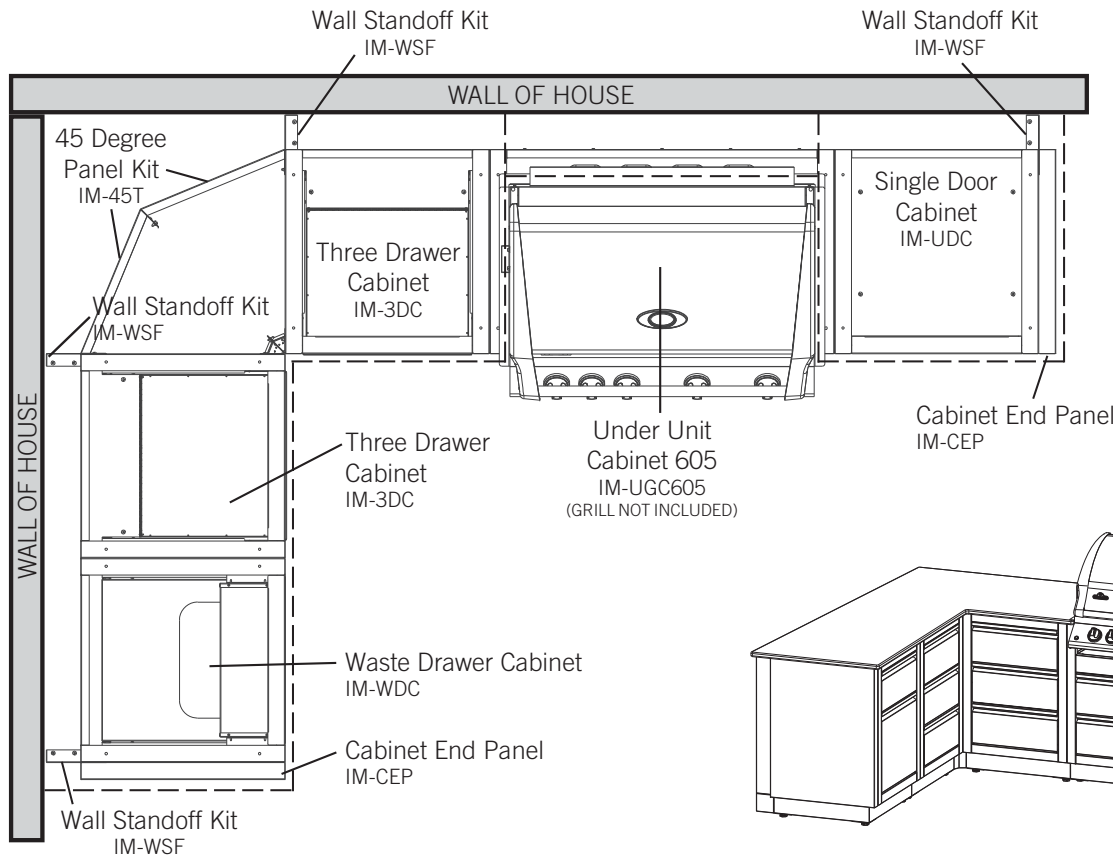

Oasis™ Modular Island Sample

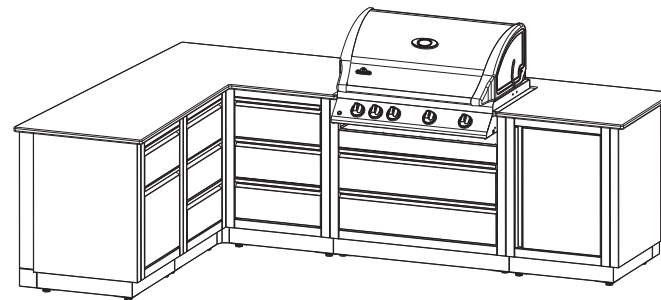

Countertops must be ordered and supplied locally by the homeowner.

The countertop material must be non-combustible if a grill is to be installed into it. They can be ordered in advance by drawing out the floor plan of how the cabinets will be situated and adding up the width measurements, allowing 1-2 inches of countertop overhang. Most countertop manufacturers are willing to come and take measurements after assembly of the cabinets is complete to ensure a perfect fit. For best results the countertop thickness should be between ¾ to 1 ½" thick. The built-in grill head comes with stainless steel brackets and hardware that allow the unit to rest on the countertop above the corresponding island cabinet for that unit. Granite is an excellent choice of countertop materials. Decorative countertops made of ceramic tile set on top of cement tiling board can be selected to match your surrounding backyard furniture colour.

BUILT-IN PROPANE GAS HOOK-UP

The piping up to the gas grill is the responsibility of the installer and piping should be located as shown in the built-in instructions. The installation must comply with CAN B149.1 Natural Gas and Propane installation code in Canada, or to the National Fuel Gas code, ANSI Z223.1 in the United States. The tank can not be stored below the gas grill. Built-in units are supplied with a drip pan which holds only a minimal amount of grease. To prevent grease fires, the pan must be cleaned after each use.

INSTALLATION SPECIFICATIONS

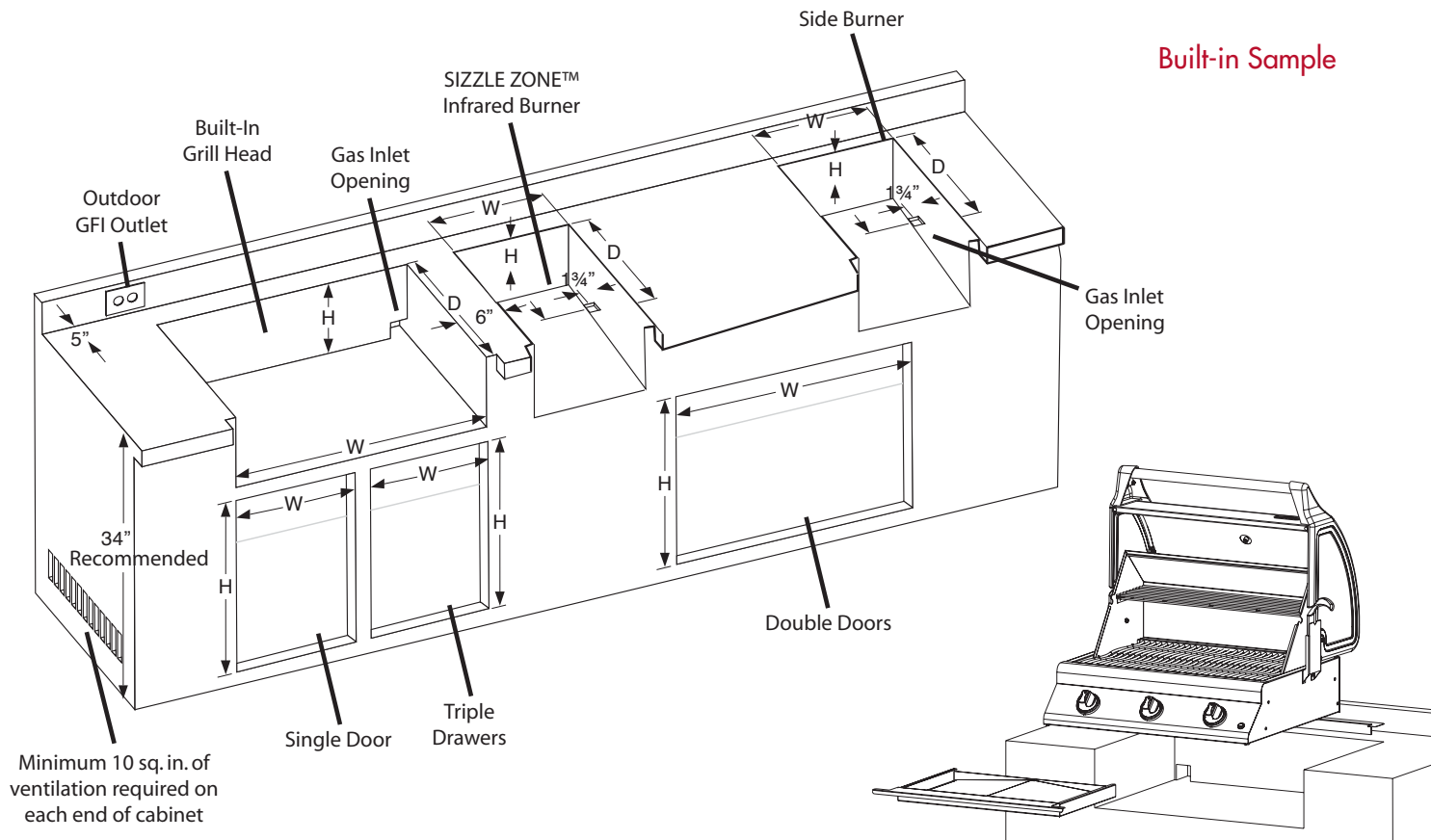

* Additional clearance may be required for openings. See owners manual

Please use manual to properly assemble your built-in grill. Refer to the main manual for operating, cleaning, and maintenance instructions. This grill is designed for non-combustible enclosures only (unless the Napoleon® zero clearance kit is utilized), and must be installed and serviced by a qualified installer to local codes.

Drawings for reference only. Minimum 6" clearance required between grill and other appliance. Specifications subject to change without notice.

BUILT-IN NATURAL GAS HOOK-UP

The piping up to the gas grill is the responsibility of the installer and piping should be located as shown in the built-in instructions. Do not use hose to connect the unit. It must be connected with rigid pipe, copper tube or an approved flexible metal connector which complies with Z21.4 /CSA 6.10. The installation must comply with CAN B149.1 Natural Gas and Propane Installation Code in Canada, or to the National Fuel Gas Code, ANSI Z223.1 in the United States. The gas supply pipe must be sufficiently sized to supply the BTU/h specified on the rating plate, based on the length of the piping run. If installing a side burner, a separate line must be branched off to the side burner unit and enter the side burner opening at the specified location.

THE ANATOMY OF THE PERFECT OUTDOOR KITCHEN





GRILL SPECIFICATIONS	BIPRO600RBI	BIPRO500RB	BIPT750RBI	BIP500	BIPF600	BIPF450	BIU405RB	BIM730RBI	BIM605RBI	BIM485RB
LIFT EASE® roll top lid	S	S	S	S	S	S	-	S	S	S
ACCU PROBE® temperature gauge	S	S	S	S	S	S	S	S	S	S
Total cooking surface (sq. in.)*	922	760	1160	760	1100	890	570	1025	850	675
Electronic ignition	S	S ^o	S	-	S	S	S	-	-	-
JETFIRE® ignition	-	S	-	S	-	-	-	S	S	S
Infrared ceramic bottom burners	1	-	2	-	2	1	-	1	1	-
Stainless steel bottom burners	4	4	3	4	2	2	3	4	3	3
Infrared rear rotisserie burner	S	S	S	-	S	S	S	S	S	S
Stainless steel WAVE® cooking grids	-	-	-	-	-	-	-	S	S	S
Stainless steel 9.5 mm WAVE® cooking grids	S	S	S	-	S	S	-	-	-	-
Porcelain cast iron WAVE® reversible channel cooking grids	-	-	-	S	-	-	S	-	-	-
i-GLOW® backlit control knobs	-	S	-	-	-	-	-	S	S	S
EASY SET® control knobs	S	S	S	S	S	S	S	S	S	S
Removable drip pan	S	S	S	S	S	S	S	S	S	S
Warming rack	S	S	S	S	S	S	S	S	S	S
President's Limited Lifetime Warranty	S	S	S	S	S	S	-	S	S	S

DIMENSIONS (opening size)	BIPRO600RBI	BIPRO500RB	BIPT750RBI	BIP500	BIPF600	BIPF450	BIU405RB	BIM730RBI	BIM605RBI	BIM485RB
Length (in)	37 3/4"	30 3/4"	49 3/4"	30 3/4"	55 3/4"	46 3/4"	27 1/2"	43 1/4"	36 1/2"	29 3/4"
Depth (in)	20 5/8"	20 5/8"	20 5/8"	20 5/8"	20 5/8"	20 5/8"	16 3/4"	21 3/8"	21 3/8"	21 3/8"
Height (in)	8 7/8"	8 7/8"	9 5/8"	8 7/8"	8 7/8"	8 7/8"	12"	7 1/2"	7 1/2"	7 1/2"

DOORS & ACCESSORIES	Part Number	Width	Height	Depth
Flat Stainless Steel Door	N370-0361	17"	23 1/4"	-
Flushed Mount Stainless Steel Double Door	N370-0502	28 1/4"	20 1/4"	-
Flushed Mount Stainless Steel Double Door	N370-0503	37 3/4"	20 1/4"	-
Stainless Steel Single Drawer	N370-0359	17 1/4"	6 3/4"	23"
Stainless Steel Triple Drawer	N370-0360	17 1/4"	22 3/4"	23"
Infrared SIZZLE ZONE® Burner with Roll Top	BISZ300	20 1/8"	9 5/8"	20 5/8"
Infrared SIZZLE ZONE® with Flat Top	BISZ300FT	20 1/8"	9 5/8"	20 5/8"
Double Side Burner	BISB245	20 1/8"	8 7/8"	20 5/8"
Side Burner	N370-0504/05	18"	15"	4 1/2"
Zero Clearance (2) 37"	BIZC600	44 1/8"	22 15/16"	11 1/8"

OASIS® MODULAR COMPONENTS	Part Number	Width	Height	Depth
Under Grill Cabinet - 300 series	IM-UGC300	24"	35"	24"
Under Grill Cabinet - 500 series	IM-UGC500	34 3/4"	35"	24"
Under Grill Cabinet - 600 series	IM-UGC600	42"	35"	24"
Under Grill Cabinet - 750 series	IM-UGC750	53 3/4"	35"	24"
Under Grill Cabinet - 485 series	IM-UGC485	34 3/4"	35"	24"
Under Grill Cabinet - 605 series	IM-UGC605	40 1/2"	35"	24"
Under Grill Cabinet - 730 series	IM-UGC730	47 1/4"	35"	24"
Propane Tank Cabinet - universal door	IM-UTC	24"	35"	24"
Universal Door Cabinet	IM-UDC	24"	35"	24"
Fridge Cabinet	IM-FDC	24"	35"	24"
Three Drawer Cabinet	IM-3DC	24"	35"	24"
Two Drawer Cabinet	IM-2DC	24"	35"	24"
Waste Drawer with Paper Towel Holder	IM-WDC	24"	35"	24"
Cabinet End Panel	IM-CEP	2"	31"	24"
Cabinet Transitions - 45 degrees	IM-4ST	18 3/8"	35"	-
Wall Spacer	IM-WSF	1 1/2"	35"	4"
Ice Bucket Holder	IM-IBA	19 1/8"	1 3/16"	16"

S = Standard O = Optional ° Rear burner * All lid openings require a minimum of 5" clearance behind the unit. Refer to owners manual for individual models. - Dimensions subject to change. Refer to manual for accurate dimensions

Other Napoleon Products



Fireplace Inserts • Charcoal Grills • Gas Fireplaces • Waterfalls • Wood Stoves
 Hybrid Furnaces • Electric Fireplaces • HVAC Equipment • BBQ Accessories



- 214 Bayview Drive, Barrie, Ontario, Canada L4N 4Y8
- 103 Miller Drive, Crittenden, Kentucky, USA 41030
- 7200 Trans Canada Highway, Montreal, Quebec H4T 1A3

PHONE: 705-726-4278 • FAX: 705-725-2564
 napoleongrills.com
 info@napoleonproducts.com

Approved by Intertek Testing Services to standards in the USA and Canada: ANSI Z21.58 / CSA 1.6 - Outdoor Cooking Gas Appliances. All specifications and designs are subject to change without prior notice due to ongoing product improvements. Consult your owner's manual for complete installation and operating instructions and check all local and national Building Codes and Regulations. Not all features available on all models. Napoleon is a registered trademark of Wolf Steel Ltd. The red knob design is a trademark of NAC. Images and colors may not be exactly as shown.

Authorized Dealer

Printed in Canada
 ADBRBI 02/2013