

# Use & Care Guide

## Tumble dryer

Save these instructions for future reference

*Dear ASKO customer,*

*Thank you for choosing this quality product from Scandinavia, made in Vara, Sweden.*

*We want you to feel assured that the inside of your new machine is just as good as the outside and that the ethics and standards that went into the production of this machine are just as high as the quality and performance that you will receive from it. We hope that this product will give you many years of pleasure.*

*To get the most out of your new machine, we recommend that you read the operating instructions before using the machine.*

**ASKO T712C**

# Contents

Before using your machine for the first time	3
Important Safety instructions	4
Child safety	5
Options buttons	7
Advice and tips before you tumble-dry	8
Operating instructions	9
Consumption values	12
Care and maintenance instructions	13
Troubleshooting	15
Technical information	16
Service and guarantee	17
Installation instructions	19
Reversing the door hinge	23
Search words	25
Notes	26
Notes	27
Quick guide	28

# Before using your machine for the first time

## **Do not tumble-dry**

Certain materials are sensitive to tumble-drying. Always check and follow an item's laundry label. You can read more on page 9, "Before tumble-drying".

## **Note!**

When starting the tumble dryer for the first time or after a long period without use, you may notice a slight thumping sound. This is completely normal and will disappear after a few loads.

**See the Quick Guide on the last page.**

# Important Safety instructions



## WARNING!

To reduce the risk of fire, electric shock, or injury to persons when using your appliance, follow basic precautions, including the following:

- Read all instructions before using the appliance.
- Do not wash or dry articles that have been previously cleaned in, washed in, soaked in, or spotted with gasoline, dry-cleaning solvents, cooking oils, other flammable or explosive substances as they give off vapors that could ignite or explode.
- Do not allow children to play on or in the appliance. Children should be closely supervised when near the appliance.
- Before the appliance is removed from service or discarded, remove the door to the drying compartment.
- Do not reach into the appliance if the drum is moving.
- Do not install or store this appliance where it will be exposed to the weather.
- Do not tamper with controls.
- Do not attempt to repair or replace any part of the appliance or perform any servicing unless specifically recommended in this guide.
- Do not use fabric softeners or dryer sheets unless the manufacturer gives written assurance that the product will not damage a tumble dryer.
- Do not heat-dry items containing:
  - vinyl, plastic, foam rubber or similarly textured rubberlike materials
  - fiberglass
  - wool unless the label specifies “washable”
- Clean the lint filter before or after each load.
- Keep the area around the exhaust opening and adjacent surrounding areas free from the accumulation of lint, dust and dirt.
- The interior of the machine should be cleaned periodically by an authorized ASKO service agent.
- Do not place items exposed to cooking oils in your dryer. Items contaminated with cooking oils may contribute to a chemical reaction that could cause a load to catch fire.
- Electrical installation, if required, must be done by a licensed electrician.
- Do not operate appliance while away from the home.
- Do not heat dry items that have been dry-cleaned.
- The dryer is made and marked to facilitate recycling. When it is no longer useful, contact your local refuse collection service for advice on how to properly dispose of the dryer for purposes of recycling.
- Damaged power cables should only be replaced by a certified professional.
- Provide sufficient ventilation, otherwise smoke from open fires or fumes from equipment burning other fuels can be drawn into the room.

## Caution!



During the program, the back of the dryer will get very hot. Let the machine cool completely before touching the back.

## WARNING!

This appliance must be properly grounded.

### GROUNDING INSTRUCTIONS

A) Grounding instructions for a grounded, cord-connected appliance

In the event of malfunction or breakdown, grounding will reduce the risk of electric shock by providing a path of least resistance for electric current. This appliance (Canadian market only) is equipped with a cord having an equipment-grounding conductor and a grounding plug. The plug must be plugged into an appropriate outlet that is properly installed and grounded in accordance with all local codes and ordinances.

To reduce the risk of fire, this appliance must be exhausted outdoors or the equivalent. Do not exhaust into a chimney, wall, ceiling or concealed space in a building.

## **WARNING!**

Improper connection of the equipment-grounding conductor can result in a risk of electric shock. Check with a qualified electrician or service representative or personnel if you are in doubt as to whether the appliance is properly grounded.

Do not modify the plug provided with the appliance (Canadian market only).

If it will not fit the outlet, have a proper outlet installed by a qualified electrician.

B) Grounding instructions for a permanently connected appliance:

This appliance must be connected to a grounded metal, permanent wiring system, or an equipment-grounding terminal or lead on the appliance.

NOTE: This manual does not cover every possible condition and situation that may occur. Use common sense and caution when installing, operating, and maintaining any appliance.

## **Child safety**



### **General**

**Do not allow children to play with the tumble dryer.**

The tumble dryer has a magnetic catch, allowing the door to be opened from the inside. The door has a door-switch that automatically stops the tumble dryer when the door is opened. The tumble dryer does not start automatically when the door closes (for example, if a child closes the door from inside).

# Parts of the tumble dryer

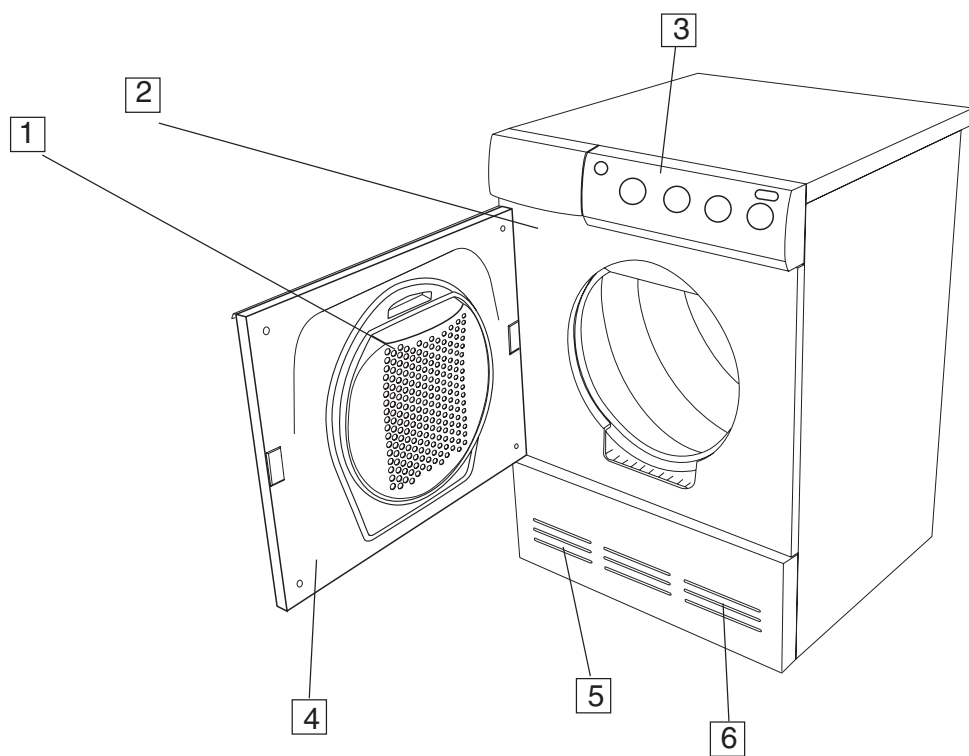

- |    |                                    |    |                                    |
|----|------------------------------------|----|------------------------------------|
| 1. | Lint filter holder                 | 5. | Fan (behind the front plate)       |
| 2. | Serial number tag and rating plate | 6. | Condenser (behind the front plate) |
| 3. | Panel                              | 7. | Lint filter                        |
| 4. | Outer door                         |    |                                    |

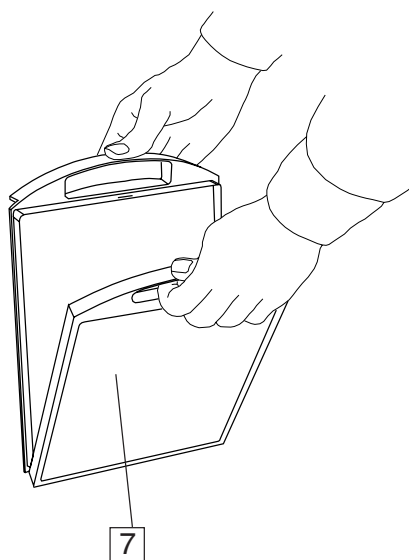

# Front panel

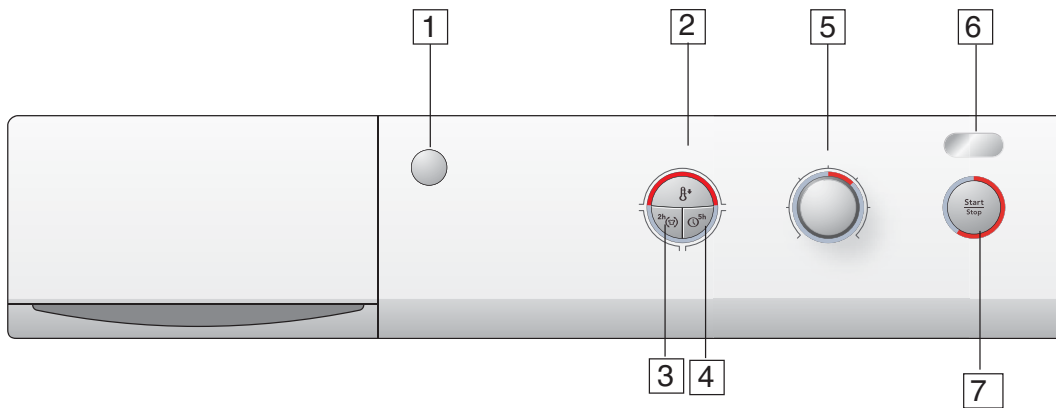

1. Main power switch
- 2-4. Options buttons
5. Program selector
6. Display
7. Start/Stop

# Options buttons

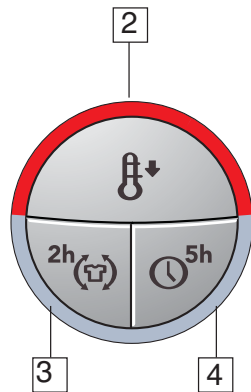

2. Button for selecting Low Temperature
3. Button for selecting Wrinkle free Program
4. Button for selecting Delayed Start 5 h

# Advice and tips before you tumble-dry

Here are some tips that may help you before you begin tumble-drying.

## **Has the load been spun in the washing machine?**

Items to be tumble-dried should be spun at 1000 rpm or faster. Better spinning saves both energy and drying time.

## **Laundry labels**

### **Materials that can be tumble-dried**

This symbol means that the material is suitable for tumble-drying. Fabrics best suited to tumble-drying are cotton fabrics, terry cloth and synthetic fibers. Garments will be softer and lighter when tumbled than when hung out to dry.

### **Note!**

Wear to fabrics in the tumble dryer is insignificant. The lint that gets caught in the lint filter consists of dust and fiber remnants formed when the items are used.

## **Materials that should not be tumble-dried**

This symbol means that the material is not suitable for tumble-drying.

Certain materials may melt or become a fire hazard if exposed to heat and others lose their shape or shrink.

## **And do not tumble-dry...**

- materials labeled “Do not dry near heat”.
- garments that have been dry-cleaned at home.
- foam plastic.
- fiberglass material.
- wool must not be tumble-dried due to the risk of piling.

# Operating instructions

## Warning!

To reduce the risk of electric shock or injury to persons, read the "Important Safety Instructions" section on page 4 before operating this appliance.

## 1 Sort your fabrics

You will achieve the most uniform drying results if the items are the same material.

Close zippers and fasten or belts; sort the items and adjust load and temperature.

## 2 Turn on the main power switch

## 3 Open the door, load the items and then close the door

## 4 Select program

The choice of program depends on what you intend to do with the items after tumbling. The program options are Heavy, Normal, Delicate, Iron dry, Timed dry program and Air fluff.

### Heavy

This program is for items that are particularly difficult to dry, such as jeans with very thick seams.

### Note!

Knit fabrics in particular are prone to shrinkage. Use the Normal, Delicate or Iron dry programs for such items. Stretch clothes back into shape immediately after drying.

### Normal, Delicate

These programs shut off the heat once the load is dry without being "bone-dry".

The Normal program shuts off the heat slightly later than Delicate. Use trial and error to find out what works best. Use these programs when you want items to be completely dry.

### Iron dry

This program shuts off the heat once the load is just damp enough for ironing or pressing.

### Timed dry program 60 min

The Timed dry program has a fixed drying time and tumble-dries the load for 60 minutes.

## 5 Air fluff 60 min

Use the Air fluff program when you just want to refresh, air, or soften up items.

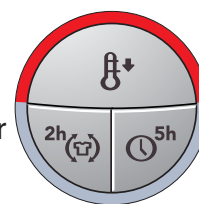

## Select option

By selecting options, you can tailor drying programs to suit your own laundry requirements. The machine remembers which settings and options you choose for each program and uses these (with one exception – Delayed Start) the next time you select the program in question. You can, of course, change them again if you wish.

### Low temperature

Select or deselect Low Temperature by pressing the Temperature button.

Once Low Temperature has been selected, the red field next to the button lights up.

### Wrinkle free

This option means that the drum will rotate three seconds per minute for two hours once the drying program has finished. This option prevents the items remaining in the same position and becoming wrinkled.

A useful feature if you are not able to remove the load as soon as tumble-drying has finished.

A lighted red field by the button indicates that the Wrinkle free option has been activated.

### Delayed Start

Select or deselect this option by pressing the Delayed Start button. The machine will start the program 5 hours after you select this option + the Start/Stop button.

A lighted red field by the button indicates that the option has been activated. If you change your mind, press the Start/Stop button for three seconds. You can now start the machine as usual.

## 6 Press the Start button

### Drying time remaining

An estimate of the remaining drying time will be shown in the display within 2 minutes of the drying program starting. For example, 1:35 means that approximately 1 hour and 35 minutes remain until the load achieves the selected level of dryness. If the Wrinkle free option has been selected, the drum will rotate every minute for 2 hours after cooling.

### If you want to stop or change a program

Press and hold the Start/Stop button for 3 seconds. The red field next to the button goes out.

### Note!

The program is not affected if the program selector is changed after the program starts.

### To load or remove laundry

If you want to load or remove washing once you have started the machine, open the door and the machine will stop automatically. Load more laundry, close the door and press the Start/Stop button.

## 7 Drying program finished

The text **End** in the display indicates that the program has finished. If the Wrinkle free option has been selected, the drum will rotate every minute for 2 hours after cooling.

### Important!

- Clean the lint filter after each load.

### Caution!

If the lint filter becomes clogged, the machine's automatic overheating cut-off may be triggered. To enable the machine to be restarted, the filter must be cleaned and the machine allowed to cool for around 30 minutes.

### Cleaning the lint filter

1. Grasp the filter handle and pull it towards you.
2. Pull the filter out of its holder.
3. Open the filter and remove the lint by hand scraping the back and front of both panels.
4. Fold the filter up and re-insert it into its holder. The filter may need to be cleaned if limescale deposits occur, see the "Care and cleaning" chapter.

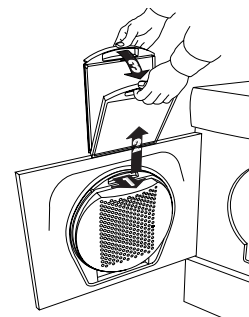

### **Automatic drain**

To install the automatic drain hose, please see the section titled Installation.

**8**

### **Once drying has finished**

Switch off the main power switch.  
Remove the clothes, and close the door to prevent small children from climbing into the machine.

# Consumption values

**For the consumption values given below, the following prerequisites apply:**

Temperature of intake air: 68°F (20°C)

Moisture content of intake air: 65%.

Drying temperature: Normal or low

Element power: 2500 W

Before tumble-drying, cotton fabrics are spun at 800 and 1600 rpm (long spin).

Before tumble-drying, other fabrics (wrinkle-resistant and acrylic) are spun at 800 rpm (short spin).

Program	Material	Temperature	Max. load (lb/kg)	Energy consumption (approx. kWh)		Program time (approx. min.)	
				800 rpm	1600 rpm	800 rpm	1600 rpm
Heavy	Cotton, linen	Normal	13/6.0	5.0	4.1	155	130
Normal	Cotton, linen	Normal	13/6.0	4.2	3.2	130	100
Normal	Wrinkle-resistant, polyester/cotton	Normal	7/3.0	1.8	-	60	-
Delicate	Cotton, linen	Normal	13/6.0	3.8	2.9	120	95
Delicate	Wrinkle-resistant, polyester/cotton	Normal	7/3.0	1.7	-	55	-
Delicate	Acrylic, rayon, acetate	Low	7/3.0	2.1	-	80	-
Iron dry	Cotton, linen	Normal	13/6.0	3.4	2.3	105	75

# Care and maintenance instructions

## Cleaning the lint filter

The lint filter must be cleaned after each load.

If you have very hard water, this can cause limescale deposits in the lint filter. Check for any limescale deposits when cleaning the lint filter and, if necessary, wash down the filter by hand using a soft brush and dish-washing detergent.

1. Grasp the filter handle and pull it towards you.
2. Pull the filter out of its holder.

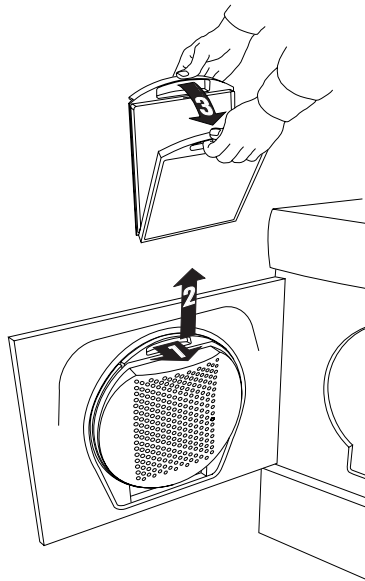

3. Open the filter and remove the lint from all sides by hand. Use a soft dry cloth to remove any coating.

4. Replace the filter in its holder.

### Note!

If you have hard water, the filter should be washed down with water to get rid of any limescale deposits.

Dry the filter carefully with a towel.

## Cleaning the outside of the machine

Clean the outside of the machine and the program panel with a mild cleaner. Do not use any solvents, as these can damage the machine. Do not hose down or spray the machine with water.

### Note!

Do not allow dust to accumulate around the machine. Keep the area around the tumble dryer clean and cool; dust, heat and moisture prolong drying times.

## Cleaning the condenser

The condenser should be cleaned at least three times a year. If you have pets, the condenser must be cleaned more frequently.

1. Switch off the main power switch.

2. Remove the front plate.

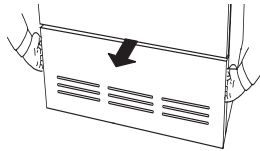

3. Open the condenser panel by turning the two knobs counterclockwise.

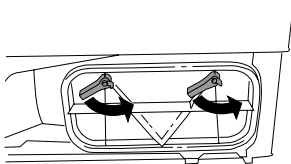

4. Remove the condenser and rinse the coils clean, using a hand shower, for example. Do not poke around in the coils, as you may damage the condenser. Do not use pointed metal objects during cleaning.

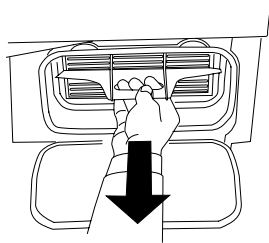

### Note!

Do not put the condenser in a dishwasher.

5. Replace the condenser. When reinstalling the condenser, check that it is replaced properly. The top of the condenser is labeled “upp”, “up” and “oben”.

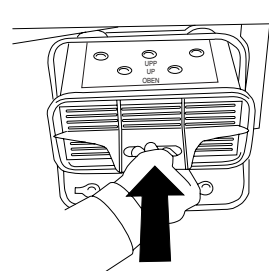

6. Replace the front plate.

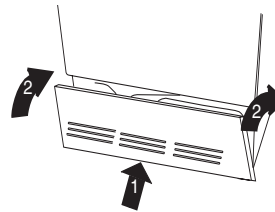

# Troubleshooting

## The machine will not start

Check

- that the outer door is properly closed.
- that the main power switch is pressed.
- that you have set the program correctly.
- that the Delayed Start option has not been selected. If so, the time remaining until start will be shown in full hours in the display (e.g. 5, 4, 3h) .
- that any plug is connected.
- that your home's fuses (circuit breakers) are intact, swap two circuit breakers. You cannot always tell from outside if a circuit breaker is broken.
- that the overheating cut-off has not been triggered (see below).

## Overheating cut-off

The overheating cut-off shuts off the tumble dryer if the temperature is too high, caused by lint clogging the lint filter, for instance.

- Clean the filter.
- Check to see if the lint filter is dirty and clean it if necessary. See "Care and cleaning".
- The overheating cut-off will reset automatically once the machine has cooled.

## Drying takes too long

- Check that neither the lint filter nor the condenser are clogged. See "Care and cleaning".
- Prolonged drying times may also be due to the condenser dryer being placed in a room that is too small and the air in the room (cooling air) being too hot.
- Make sure that the tumble dryer has access to more cold air, by opening doors and/or windows, for example.

## Error messages

- If **F1** flashes in the display, the condenser drain hose could be blocked.

Remove the hose from the drain and check for obstructions. The hose should be inserted no more than 5 or 6 inches into the wall drain.

- If **F2** flashes in the display, the maximum permitted program time has been reached. For remedial action, read "Drying takes too long" in the "Troubleshooting" section.

# Technical information

## Technical data

Height:	33.5" (850 mm)
Width:	23.4" (595 mm)
Depth:	23" (585 mm)
Weight:	104 lb (47 kg)
Cylinder volume:	29.3 gal (111 l)
Max. drying capacity:	13 lb (6.0 kg)
RPM:	52 rpm
Rated power:	See serial number tag and rating plate.
Drying drum material:	Stainless steel.
Outer casing material:	Powder-coated and hot-galvanized sheet steel or stainless steel.
Setup:	Stacking or freestanding.
Drain:	80" (2.0 m) rubber hose

# Service and guarantee

Be sure to complete the Warranty Registration Card you received with your appliance and mail it to AM Appliance Group to validate your appliance warranty. Cosmetic damage must be reported to your dealer within five days from the date of purchase. After unpacking the dryer, thoroughly check the unit for cosmetic damage.

<b>For residential installations only</b>	<b>AM Appliance Group will pay for:</b>
<b>Length of warranty</b> <b>Three-Year Full</b> From date of purchase.	ASKO replacement parts and/or repair labor to correct defect in materials or workmanship. Service must be provided by an authorized ASKO service agent.
<b>Fourth &amp; Fifth Year Limited</b> Three year full plus fourth and fifth year limited from date of purchase.	ASKO replacement parts (labor cost not included) for any defective solid-state controls, timers, motors, or pumps. Service must be provided by an authorized ASKO service agent.
<b>Lifetime</b>	ASKO replacement parts (labor cost not included) of the stainless steel tank if it fails to hold water due to a manufacturing defect, such as rusting or cracking. Service must be provided by an authorized ASKO service agent.
<b>For non-residential installations</b> <b>Six-Month Full Warranty</b> From date of purchase.	ASKO replacement parts and/or repair labor to correct defect in materials or workmanship. Service must be provided by an authorized ASKO service agent.

**AM Appliance Group will not pay for:**

- A. Service calls to:
  - 1. Correct the installation of the appliance.
  - 2. Repair damage due to shipment, delivery, installation, misuse or abuse.
  - 3. Instruct how to use the appliance.
  - 4. Replace house fuses or correct house wiring.
  - 5. Correct house plumbing, including drainage problems related to improper installation.
  - 6. Clean or service air device in drain line.
- B. Repair and/or replacement parts for failure of product if appliance is used for other than home/residential use.
- C. Damage resulting from accident, fire, floods, acts of God, alteration, misuse, abuse, improper installation, or installation not in accordance with local electrical or plumbing codes.
- D. Any shipping costs for parts during the limited warranty period.
- E. Replacement parts or repair labor costs for units operated outside the continental United States.
- F. Pickup and delivery. ASKO washers are designed to be repaired in the home.

**In no event shall AM Appliance Group be responsible for any incidental or consequential damages.**

Some states will not allow the exclusion or limitation of incidental or consequential damages, so this exclusion or limitation may not apply to you. This warranty gives you specific legal rights and you may also have other rights which vary from state to state.

**For warranty service, contact our Customer Care Center at the number listed below.** Before calling for service or contacting AM Appliance Group regarding a warranty issue, make a note of the model, type name, and serial number.

**Write to us at:**

**AM Appliance Group  
P. O. Box 851805  
Richardson, Texas 75085-1805  
www.askousa.com**

Or contact our  
Customer Care Center at  
1-800-898-1879  
www.askousa.com

# Installation instructions

## Positioning the tumble dryer

The tumble dryer can be installed free-standing or stacked. Remember that the tumble dryer produces heat and should therefore not be located in a room that is too small. If the room is very small, drying will take longer due to the limited quantity of air.

### Caution!



The machine must not be installed behind a lockable door, a sliding door or a door with hinges on the opposite side to those of the tumble dryer.

### Advice!

To improve ventilation, the door to the room where the tumble dryer is located should be left open.

### Caution!



Any electrical installation should be carried out by qualified professionals.

## A. Freestanding

The tumble dryer can be positioned beside the washing machine.

## B. Stacking

The tumble dryer can be placed on top of an Asko washing machine. To stack the dryer, you need to the stacking attachments that come with the machine. There will be: 2 foot cups. These can be found in a bag in the drum.

2 anti-tip devices. These come attached to the bottom left corner on the back of the machine.

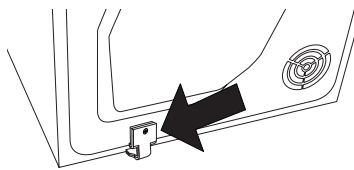

## C. Built-in

ASKO dryers can be installed beneath a cabinet or worktop with a minimum height of 34" (864 mm). There must be a gap of about 1/2" (12 mm) all around the machine, including between the rear edge of the machine top panel and the back wall. The opening width must be at least 24-1/2" (622 mm).

The condensing models work best when they have good air circulation. Therefore, we don't recommend they be installed beneath a cabinet. If it is necessary, however, be sure to leave a gap of at least 1/2" (12 mm) on all sides.

Install the dryer so the condensed water will continuously flow into a drain or sink, you will need a drain outlet behind the unit. The maximum drain height is 40" (1016 mm).

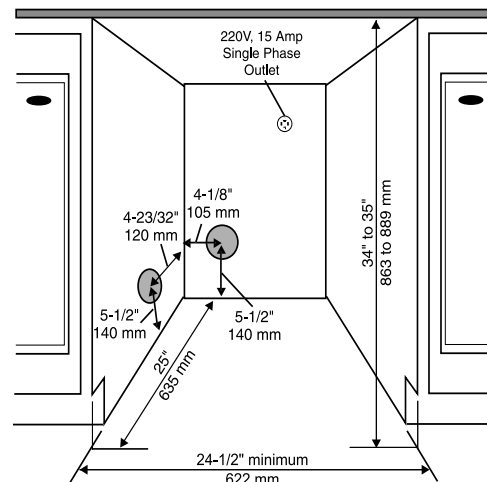

### NOTES:

The height adjustment for the dryer is 33-1/2" to 34-1/2" (850 mm to 876 mm). Do not raise it higher than 34-1/2".

Hole measurements are from center of hole.

### How to install the stacking kit:

1. Remove the two screws indicated on the back of the washing machine.

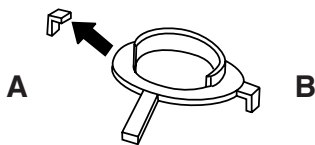

2. Secure the anti-tip device using the screws as shown in the picture.

3. Attach the plastic cups for mounting the tumble dryer's front feet to the washing machine's top cover. This is essential, as once the tumble dryer's feet are resting in

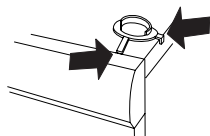

the plastic cups you know the dryer is correctly positioned on the washing machine. Break off tab **A** on the cup fitted on the right side and tab **B** on the cup fitted on the left side. Then remove the paper from the self-adhesive surface under the plastic cups.

4. Fit the plastic cups so that the tabs marked with arrows are against the front of the control panel and side edges and press firmly onto the top of the unit. Then break off the remaining tabs.

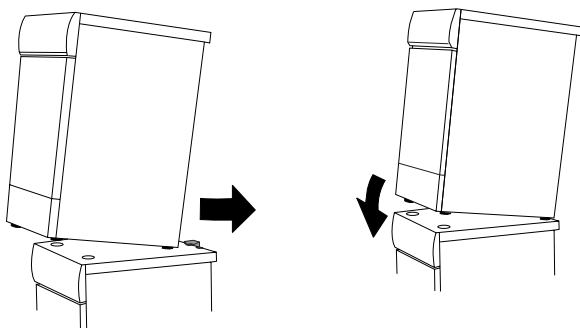

### Adjusting the feet

Screw the feet in or out so that the tumble dryer is steady and balanced on the floor or on the washing machine. Then tighten the locking nuts.

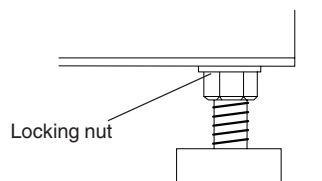

### Condensed water

Install the dryer so the condensed water will continuously flow into a drain or sink. To do this, follow the instructions below:

1. Disconnect the short hose (1) from the blue connection. (It's okay to let the hose hang down.)
2. Connect the rubber hose supplied with the dryer to the blue nipple (2).
3. Run the hose to a drain or sink, as illustrated.

#### NOTE:

The drain hose must not be more than 40" above the floor.

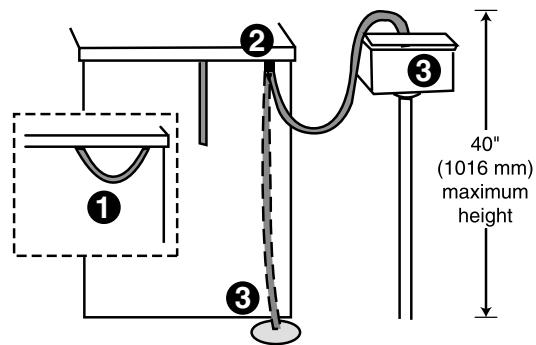

## Electrical installation

### WARNING!

This appliance must be properly grounded. Refer to the “Important Safety Instructions” on page 2 for grounding instructions.

The power supply cord must be grounded. If the machine is to be used in a wet area, the supply must be protected by a residual current device.

Connection to a permanently wired supply point must be made only by a qualified electrician.

As supplied:

Single-phase,  
230 V, 60 Hz, 2500 Watt heater rating 30 A fuse required

### WARNING:

The receptacle on the rear of the machine is designed to accommodate ASKO washers ONLY (rated 208–240 V.) To use this receptacle, you must use the ready-fitted plug supplied with the washing machine or an equivalent.

ASKO washers rated 208–240 V have two internal fuses of 15 A each.

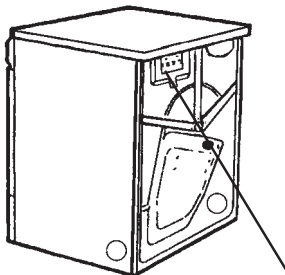

Remove cover to access terminal box. (Requires a 20-Torx screwdriver.)

### Note:

In Canada, the dryer is delivered ready-fitted with a four-prong plug intended for connection to a single-phase supply.

## Connecting a 3-wire Power Cord

### WARNING!

Before starting this procedure, be sure the power is turned off at the breaker/fuse box. Power Supply Cord

You will need a 3-wire power supply cord with three No. 10 copper wires and a matching 3-wire receptacle of NEMA Type 10-30R, as illustrated below:

To connect a 3-wire power cord to the dryer, follow the steps below.

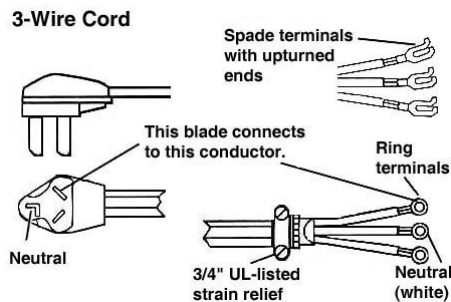

NOTE: The numbers in the illustration below correlate to the step numbers.

1. Turn the power off at the breaker/fuse box.
2. Remove terminal block cover.
3. Use the strain relief attached below the terminal block opening.
4. Loosen or remove center terminal block screw.
5. Connect neutral (white) wire of power supply cord to the center, silver-colored terminal screw. Tighten screw.
6. Connect the other wires to outer screws.
7. Tighten the strain relief screws.
8. Replace terminal box cover on back of dryer.
9. Plug dryer into wall receptacle.
10. Turn power on at breaker/fuse box.

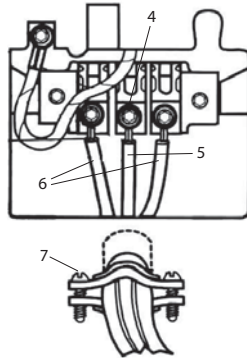

## Connecting a 4-wire Power Cord

### WARNING!

Before starting this procedure, be sure the power is turned off at the breaker/fuse box. Power Supply Cord

You will need a 4-wire power supply cord with four No. 10 copper wires and a matching 4-wire receptacle of NEMA Type 14-30R, as illustrated below.

The fourth wire must be identified with a green cover and the neutral conductor by a white cover.

To connect a 4-wire power cord to the dryer, follow the steps below.

NOTE: The numbers in the illustration below

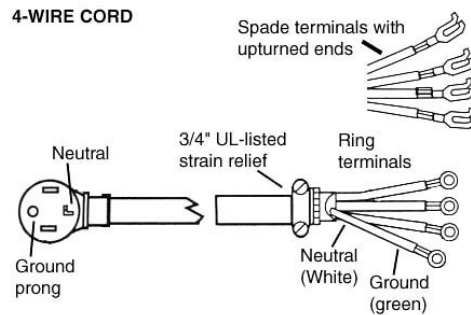

correlate to the step numbers.

1. Turn the power off at the breaker/fuse box.
2. Remove terminal block cover.
3. Use the strain relief attached below the terminal block opening.
4. Remove center terminal block screw.
5. Remove ground wire (green with yellow stripes) from external ground connector screw. Fasten under center, silver-colored terminal block screw.
6. Connect ground (green) wire of cord to external ground conductor screw.
7. Connect neutral (white) wire of cord under center screw of terminal block.
8. Connect the other wires to outer screws.
9. Tighten the strain relief screws.
10. Replace terminal box cover on back of dryer.
11. Plug dryer into wall receptacle.
12. Turn power on at breaker/fuse box.

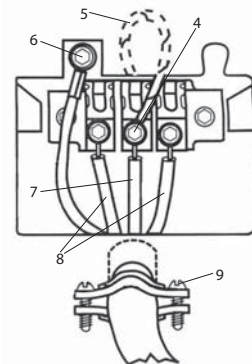

# Reversing the door hinge

The tumble dryer comes with the door hinged on the left side. However, it is possible to change the door to be hinged on the right.

## Proceed as follows:

1. Remove the lower front plate and undo the three screws holding the hinge attachment.

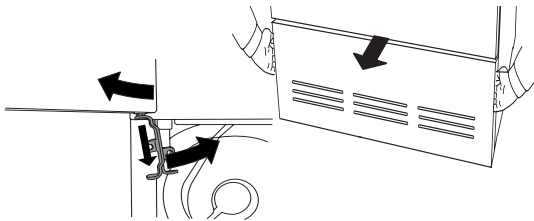

2. Angle the lower edge of the door out to the left while turning the hinge attachment as indicated by the arrows.

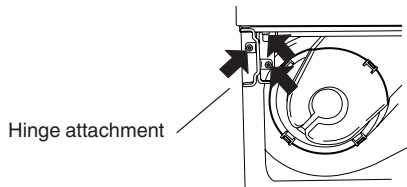

3. Move the hinge pin. To hinge the door on the right side, the hinge attachment must then be turned upside down.

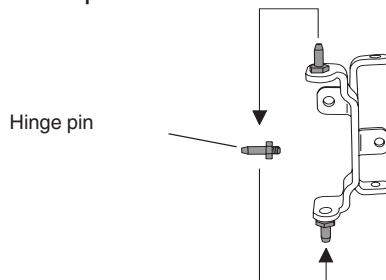

4. Then move the hinge pin in the panel's lower edge.

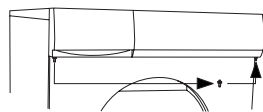

5. Next you must move the plastic plugs on the upper and lower edges of the door. Use a flat screwdriver.

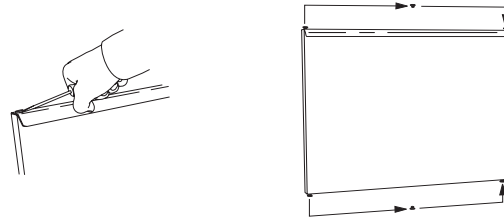

6. Unscrew the two screws on the sides of the door, around a quarter inch (five millimeters), to allow the door magnet and cover washer on the inside of the door to be removed.

7. Then remove the door magnet (1) and cover washer (2).

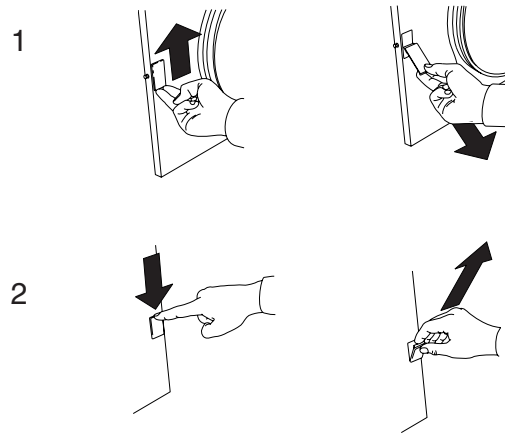

8. Insert the door magnet in place of the cover washer.



**9.** Insert the cover washer in place of the door magnet.



**10.** Insert the screws so that the door magnet and cover washer are held in place.

**11.** Remove the screw indicated. If using a condenser dryer, you must also open the condenser panel.

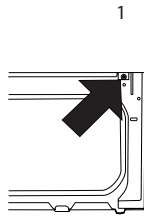

**12.** Then fit the door securely on the right side of the machine.

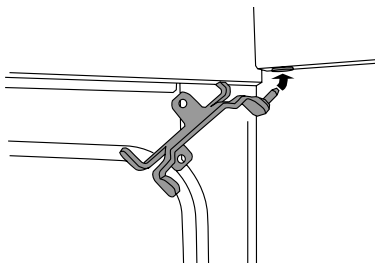
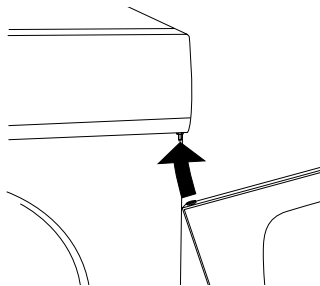

**13.** Secure the hinge attachment using the screws in the sequence shown in the picture.

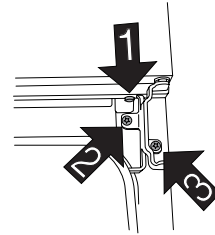

**14.** Replace the screw that was removed in figure 11.

**15.** Replace the lower front plate.

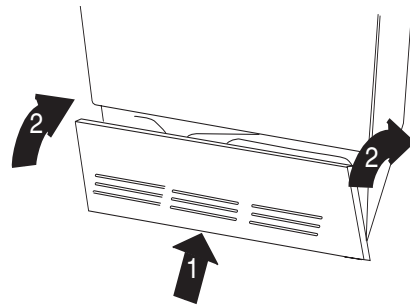

# Search words

<b>C</b>		Technical information	16
Care	10	Temperature	7, 9
Child safety	5	Transport	22
Cleaning	10, 13, 14	Troubleshooting	15
Condenser	6, 14	<b>V</b>	
Cotton	8	Wool	8
<b>D</b>		Wrinkle free	7, 9
Display	7, 10		
Do not tumble-dry	3, 8		
<b>E</b>			
Error messages	15		
<b>F</b>			
Förpackningsmaterial	21		
<b>I</b>			
Installation	19		
<b>L</b>			
Laundry labels	3, 8		
Lint filter	6, 13		
<b>O</b>			
Options	7, 9		
Overheating cut-off	15		
Overheating cut-out	10, 15		
<b>P</b>			
Piling	8		
Program	7, 9		
<b>Q</b>			
Quick guide	28		
<b>R</b>			
Reversing the door hinge	23		
<b>S</b>			
Safety	4		
Service	17, 18		
Spinning	8		
<b>T</b>			

# Notes

# Notes

# Quick guide

## 1 Fabrics

- Sort fabrics of the same kind to ensure as uniform drying as possible.



## 2 Press the main power switch

## 3 Load the laundry

- Close the door

## 4 Select a program and any options

- Turn the Program selector to the required program

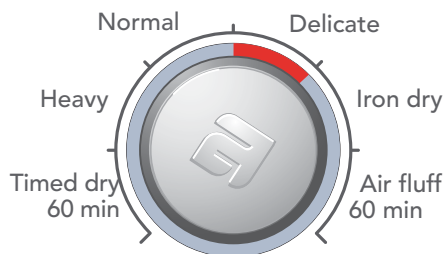

- Select any options and settings.

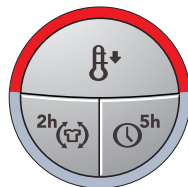

## 5 Press the Start/Stop button

## 6 Drying program finished

- The text **End** in the display indicates that the program has finished.
- Clean the lint filter after each load.

## 7 Once tumble-drying has finished

- Switch off the main power switch, and close the door.